

T U S E N                      V A R V  
( a    t h o u s a n d            t u r n s )

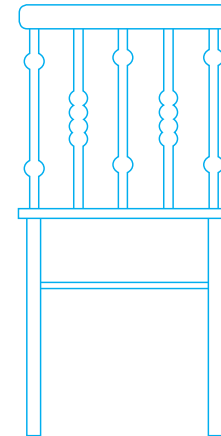
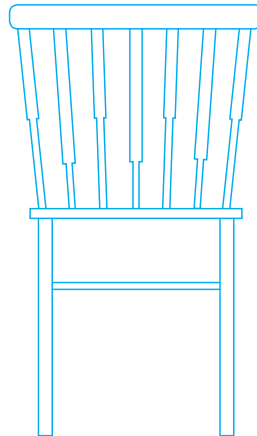
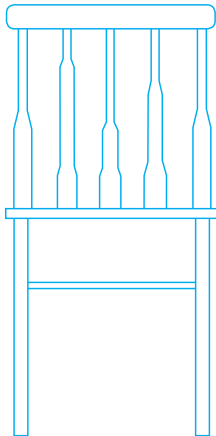

Ett designprojekt av Klara Ferm

**T U S E N                    V A R V**  
( a    t h o u s a n d    t u r n s )

Ett designprojekt av Klara Ferm



Klara Ferm, HDK-Valand, 16.03.21

I N N E H Å L L  
( c o n t e n t )

**OM PROJEKTET.....s. 4 - 5**  
(about the project)

**STOLENS GRUNDESIGN.....s. 6 - 7**  
(the design of the chair)

**PINNAR 1 - 30.....s. 8 - 67**  
(spindles 1 - 30)

**PROCESSBILDER.....s. 68 - 75**  
(images from the process)

**PINNAR 31 - 70.....s . 76 - 159**  
(spindles 31 - 70)

**PROCESSBILDER.....s. 160 - 167**  
(images from the process)

**PINNAR 71 - 100.....s .168 - 231**  
(spindles 71 - 100)

**FÄRGVAL.....s. 232 - 233**  
(colour)

## O M P R O J E K T E T

**Tusen varv är ett projekt** som föddes när jag skulle lära mig att svarva i trä. I denna process upptäckte jag att det fanns ett behov av att kontextualisera för att möjliggöra kritik. Både svarvade objekt och massproduktion förtjänar att diskuteras. Därför bestämde jag mig för att svarva pinnar till en pinnstol. Pinnstolen har varit vanligt förekommande och älskad i svenska hem sedan mitten av 1800-talet och är ett tydligt exempel på en produkt som har gått från manuell till industriell tillverkning.

**Min designfilosofi** är att på ett lekfullt och kreativt sätt vara med och utveckla pinnstolen. *Tusen varv* är ett koncept som

rör sig i gränslandet mellan hantverk och industri. Sitsen och benen på stolarna görs industriellt men pinnarna i ryggen görs manuellt. Målet är att erbjuda dig som konsument en unik möjlighet att tillsammans med mig designa personliga stolar som varar hela livet.

### **Varför Tusen varv?**

**Tusen varv** står för de många varv svarven har och kommer snurra i arbetet med pinnarna. Att visualisera tusen av någonting tycker jag är svårt. Därför betyder tusen i den här sammanhanget "ofattbart många". Tusen varv - ofattbart många varv.

## ( a b o u t t h e p r o j e c t )

**A Thousand Turns is a project** birthed and departed from the process of learning wood turning. In this learning process, it was discovered that there was a need to contextualise to enable criticism. Objects created in the lathe and mass production deserve a discussion. The obvious choice for me was therefore to create spindles for the Windsor chair. A common and loved chair in the Swedish home since the middle of the 19th century and a clear example of a product that once was manually manufactured and today is being mass produced.

**My design philosophy** is to evolve and create the Windsor chair in a playful and

creative way. *A Thousand Turns* is a concept that exists in the borderland between craft and industry. The seat and legs of the chairs are made industrially, but the sticks are made manually. My goal is to offer the consumers a unique opportunity to design a personal chair that will last a lifetime.

### **Why A Thousand Turns?**

**A Thousand Turns** stands for the many rotations the lathe spins while making the spindle. I find it very difficult to imagine a thousand of anything. Therefore, in this context, a thousand stands for "unimaginably many". A thousand turns - unimaginably many turns.

# STOLES GRUND

( t h e d e s i g n )

**Standard**  
(Standard)  
#1.1

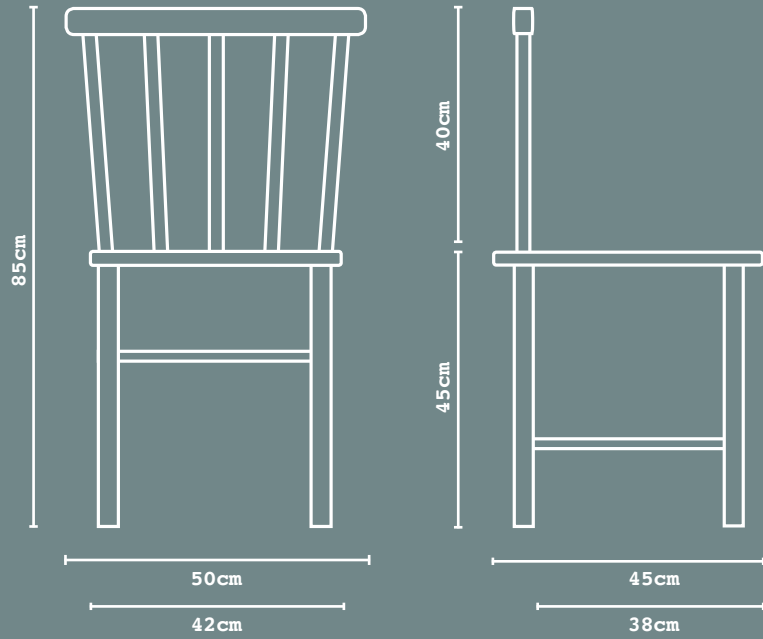

**Standard 7**  
(Standard 7)  
#1.2



**Standard Smal**  
(Standard Thin)  
#1.3



**Rak Original**  
(Straight Original)  
#2.1

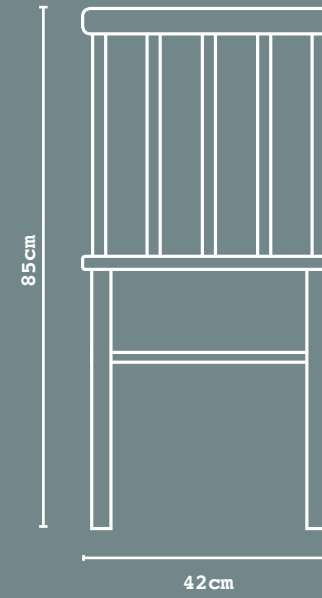

**Rak 7**  
(Straight 7)  
#2.2

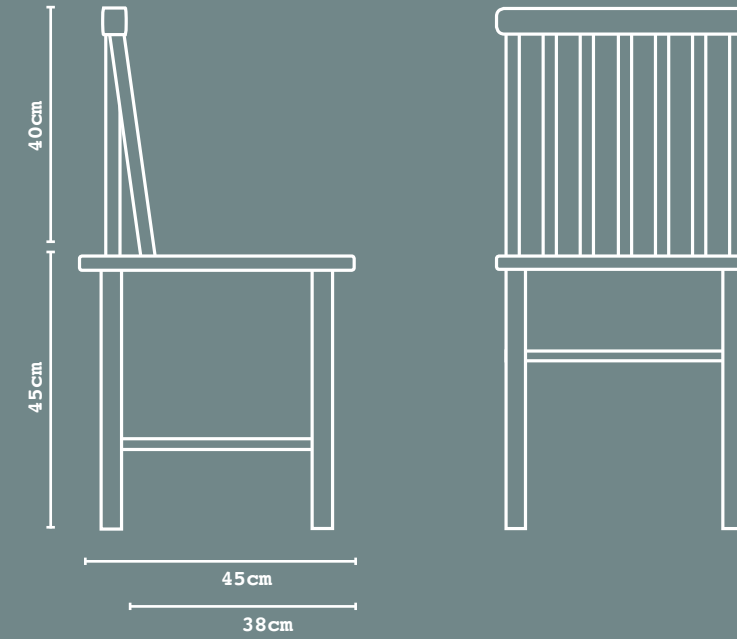

Alla grundmodeller är tillgängliga med alla pinnar.

Pinnarna kan kombineras fritt, förslag ges i katalogen.

( All designs are available with all different spindels.

You can combine the spindles as you like, suggestens are given in the catalog. )



# 001



## PRODUKTFAKTA

**Pinnar** (spindles): 1-pack / 2-pack / 5-pack

**Material** (material): **Björk** (birch)

**Färgval** (colour): s. (p.) 232 - 233

Standard  
#1.1.001

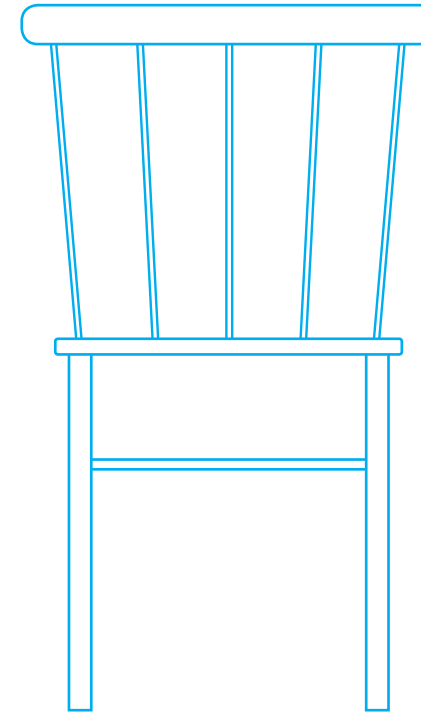

Alternativ  
#2.2.001

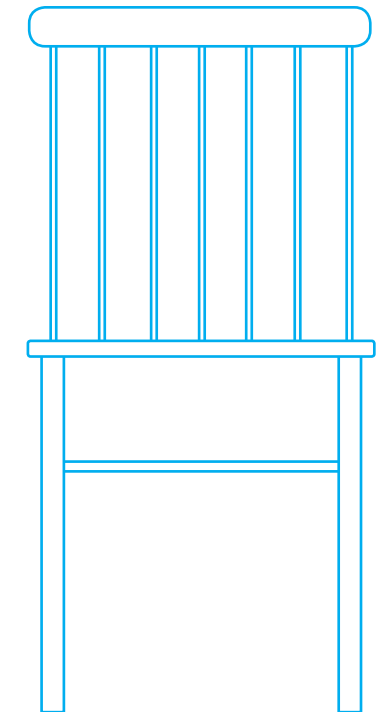

Produkten finns i flera utföranden, s. 6 - 7. (The product is available in several designs, p. 6 - 7.)

# 002



**PRODUKTFAKTA**

**Pinnar** (spindles): 1-pack / 2-pack / 5-pack

**Material** (material): **Björk** (birch)

**Färgval** (colour): s. (p.) 232 - 233

Standard  
#1.1.002

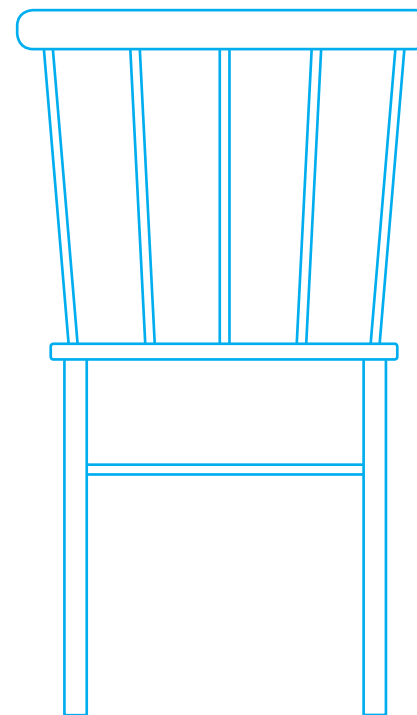

Alternativ  
#1.2.002

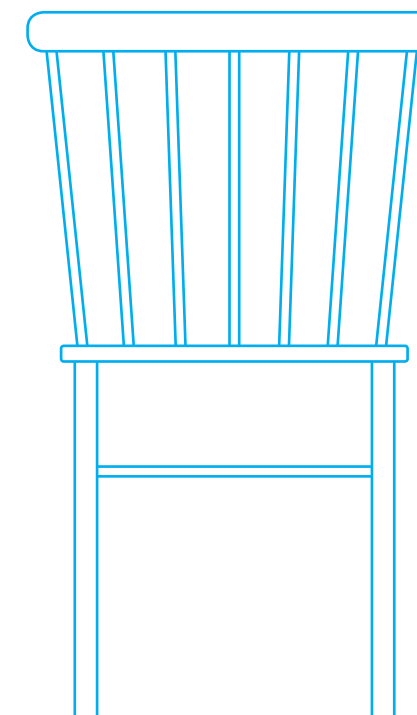

Produkten finns i flera utföranden, s. 6 - 7. (The product is available in several designs, p. 6 - 7.)



# 003

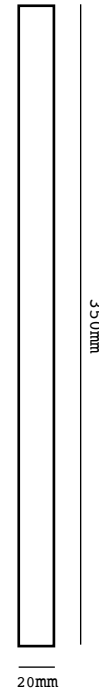

## PRODUKTFAKTA

**Pinnar** (spindles): 1-pack / 2-pack / 5-pack

**Material** (material): **Björk** (birch)

**Färgval** (colour): s. (p.) 232 - 233

Standard  
#1.1.003

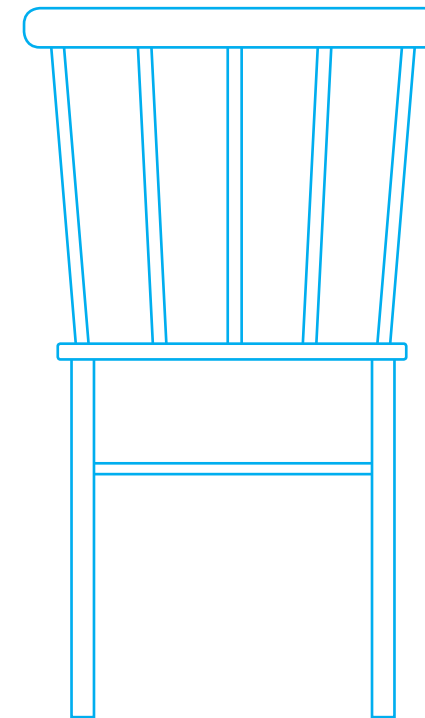

Alternativ  
#1.3.003

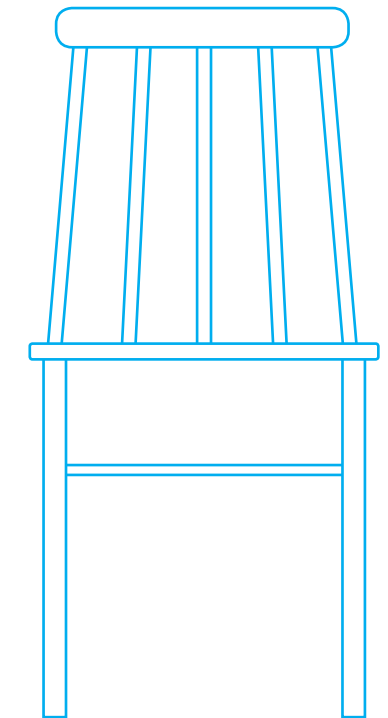

Produkten finns i flera utföranden, s. 6 - 7. (The product is available in several designs, p. 6 - 7.)





# 004

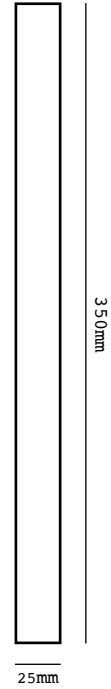

**PRODUKTFAKTA**

**Pinnar** (spindles): 1-pack / 2-pack / 5-pack

**Material** (material): **Björk** (birch)

**Färgval** (colour): s. (p.) 232 - 233

Standard  
#1.1.004

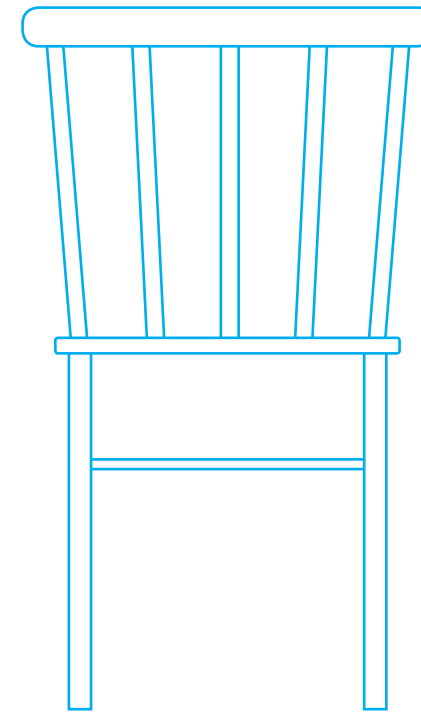

Alternativ  
#2.2.001+004

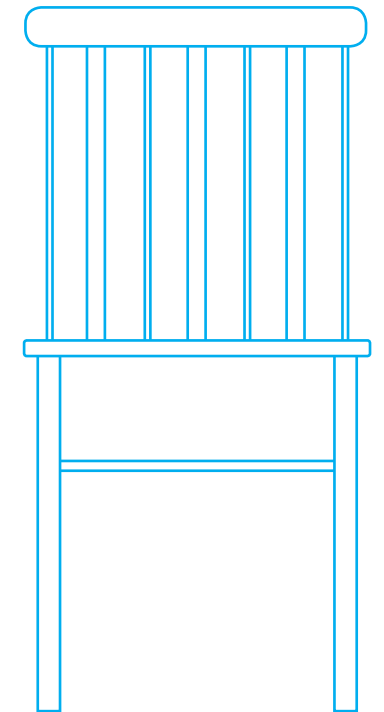

Produkten finns i flera utföranden, s. 6 - 7. (The product is available in several designs, p. 6 - 7.)

# 005

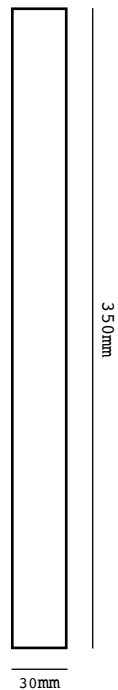

**PRODUKTFAKTA**

**Pinnar** (spindles): 1-pack / 2-pack / 5-pack

**Material** (material): **Björk** (birch)

**Färgval** (colour): s. (p.) 232 - 233

Standard  
#1.1.005

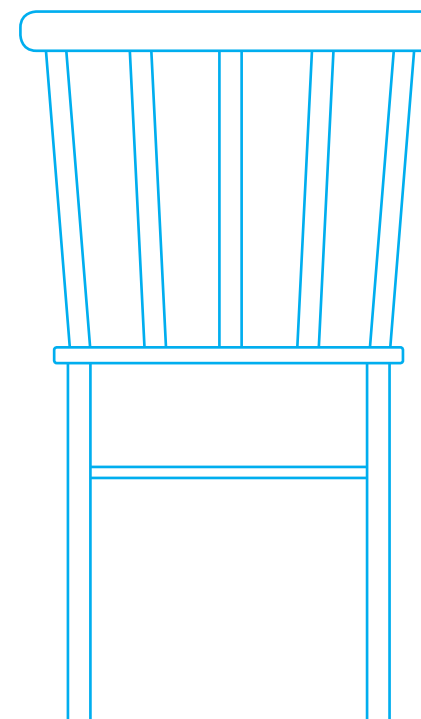

Alternativ  
#2.1.005

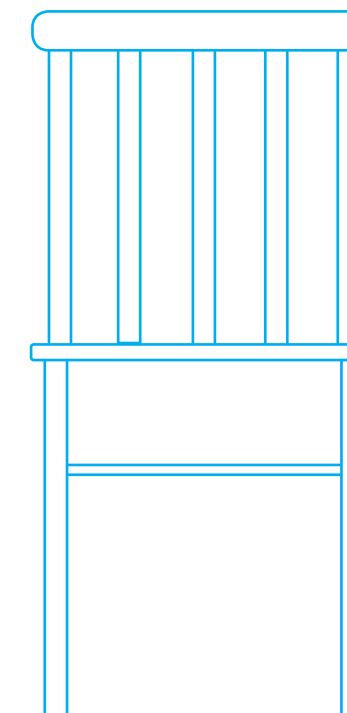

Produkten finns i flera utföranden, s. 6 - 7. (The product is available in several designs, p. 6 - 7.)



# 006

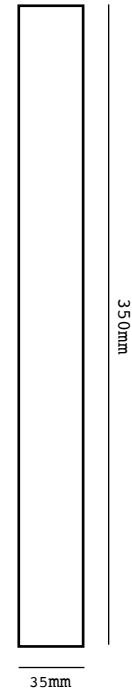

**PRODUKTFAKTA**

**Pinnar** (spindles): 1-pack / 2-pack / 5-pack

**Material** (material): **Björk** (birch)

**Färgval** (colour): s. (p.) 232 - 233

Standard  
#1.1.006

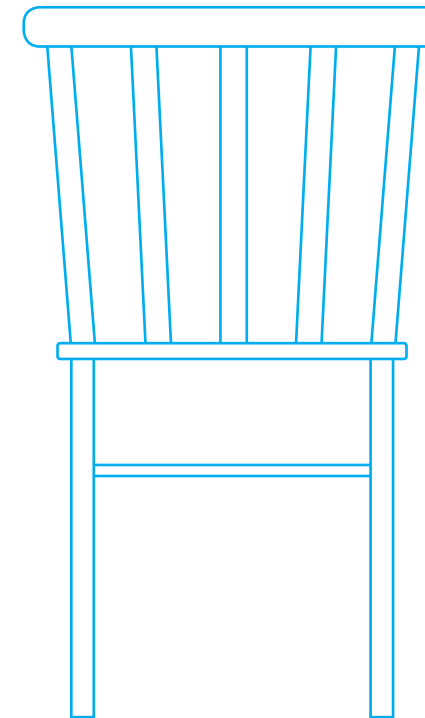

Alternativ  
#1.1.002+004+006

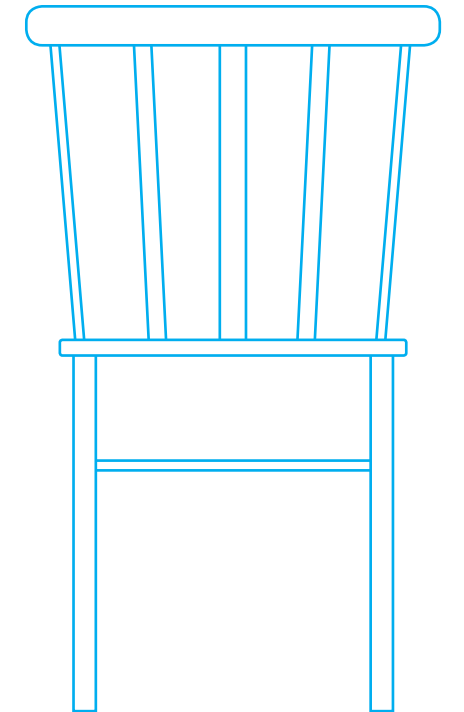

Produkten finns i flera utföranden, s. 6 - 7. (The product is available in several designs, p. 6 - 7.)



# 007



**PRODUKTFAKTA**

**Pinnar** (spindles): 1-pack / 2-pack / 5-pack

**Material** (material): **Björk** (birch)

**Färgval** (colour): s. (p.) 232 - 233

Standard  
#1.1.007

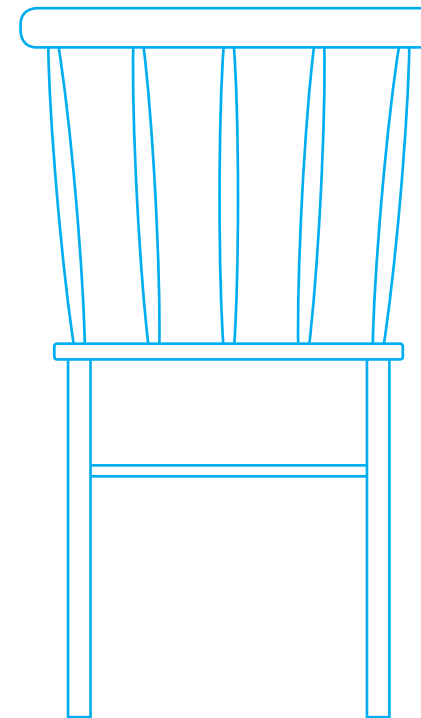

Alternativ  
#2.1.007+010

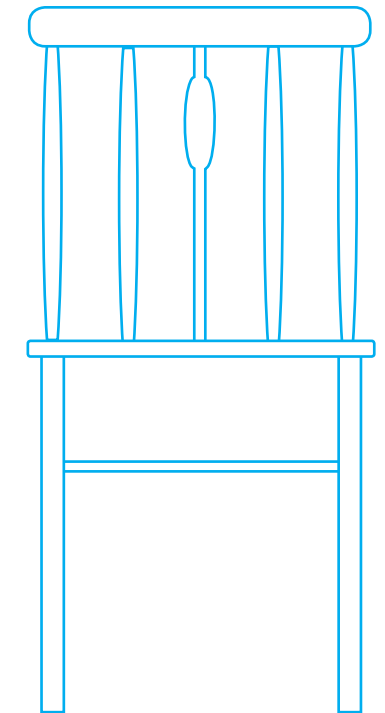

Produkten finns i flera utföranden, s. 6 - 7. (The product is available in several designs, p. 6 - 7.)



# 008

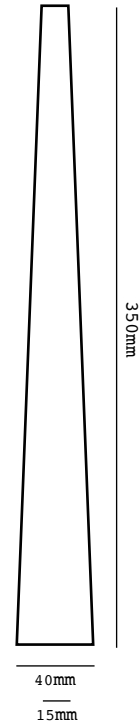

**PRODUKTFAKTA**

**Pinnar** (spindles): 1-pack / 2-pack / 5-pack

**Material** (material): **Björk** (birch)

**Färgval** (colour): s. (p.) 232 - 233

Standard  
#1.1.008

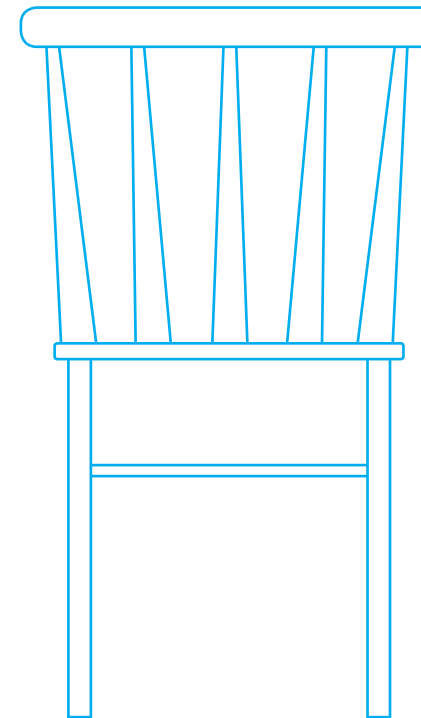

Alternativ  
#2.1.008

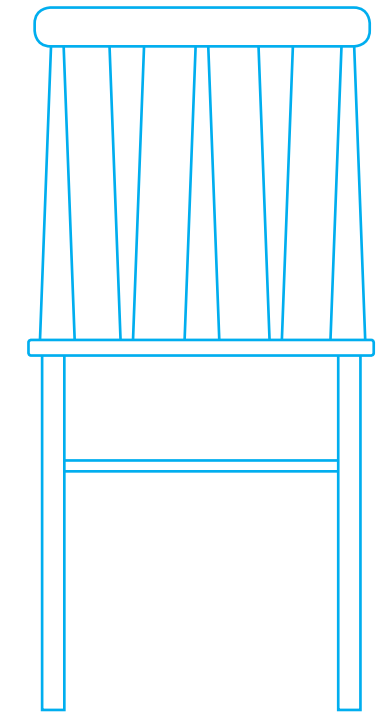

Produkten finns i flera utföranden, s. 6 - 7. (The product is available in several designs, p. 6 - 7.)



# 009

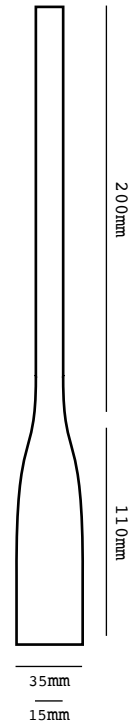

**PRODUKTFAKTA**

**Pinnar** (spindles): 1-pack / 2-pack / 5-pack

**Material** (material): **Björk** (birch)

**Färgval** (colour): s. (p.) 232 - 233

Standard  
#1.1.009

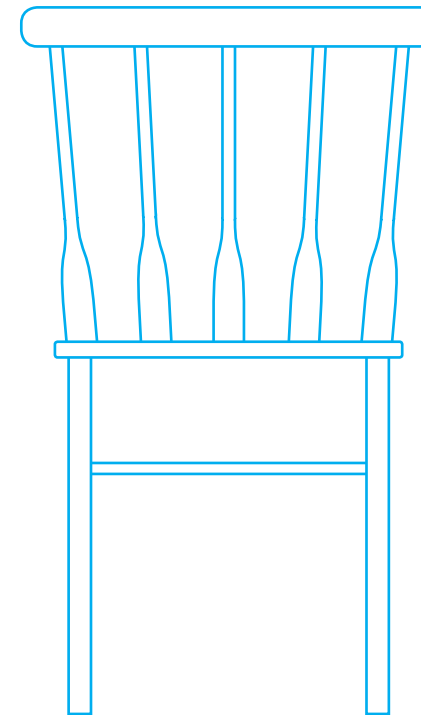

Alternativ  
#2.2.009

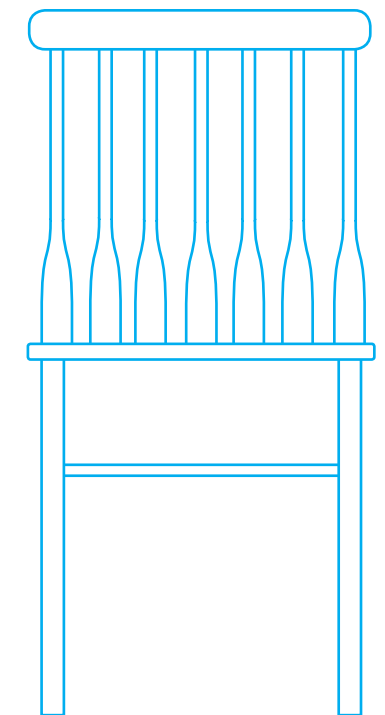

Produkten finns i flera utföranden, s. 6 - 7. (The product is available in several designs, p. 6 - 7.)



# 010

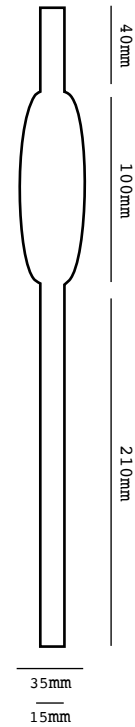

## PRODUKTFAKTA

**Pinnar** (spindles): 1-pack / 2-pack / 5-pack

**Material** (material): **Björk** (birch)

**Färgval** (colour): s. (p.) 232 - 233

Standard  
#1.1.010

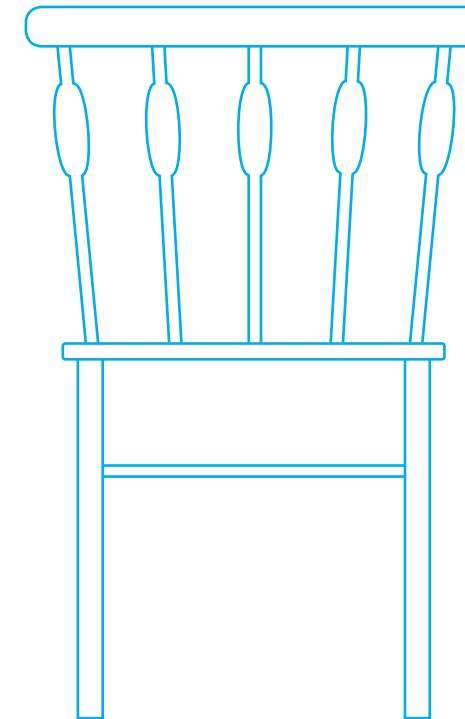

Alternativ  
#1.3.010

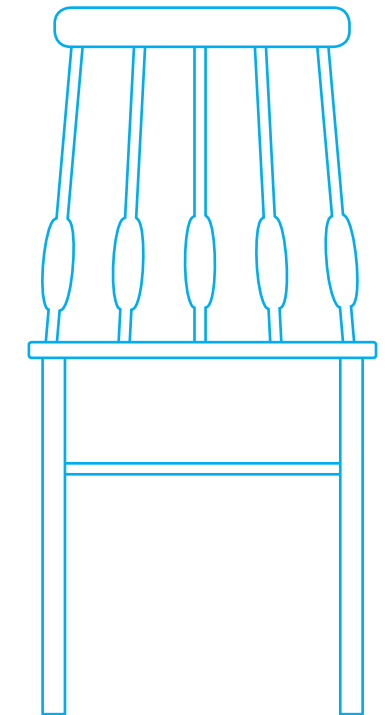

Produkten finns i flera utföranden, s. 6 - 7. (The product is available in several designs, p. 6 - 7.)



# 011

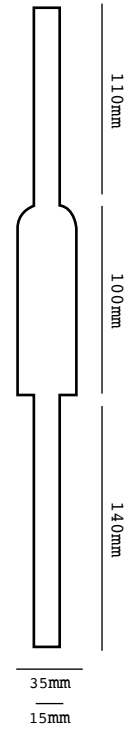

**PRODUKTFAKTA**

**Pinnar** (spindles): 1-pack / 2-pack / 5-pack

**Material** (material): **Björk** (birch)

**Färgval** (colour): s. (p.) 232 - 233

Standard  
#1.1.011

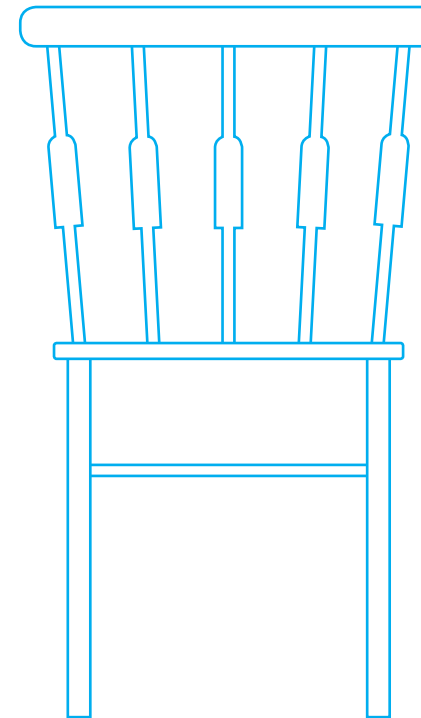

Alternativ  
#1.2.002+011

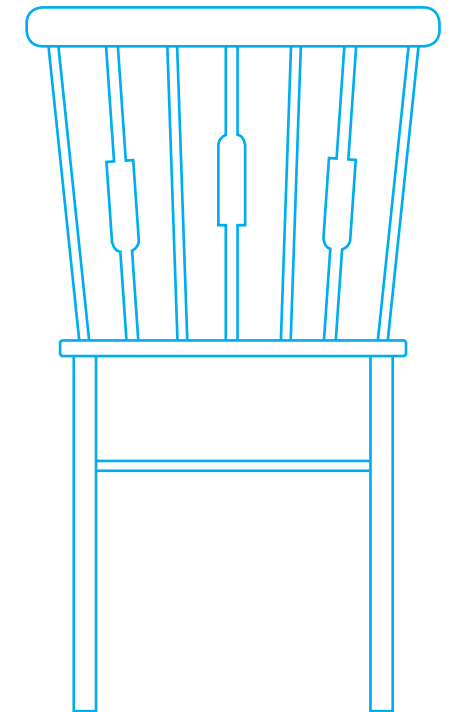

Produkten finns i flera utföranden, s. 6 - 7. (The product is available in several designs, p. 6 - 7.)





# 012

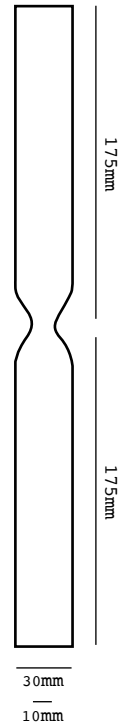

## PRODUKTFAKTA

**Pinnar** (spindles): 1-pack / 2-pack / 5-pack

**Material** (material): **Björk** (birch)

**Färgval** (colour): s. (p.) 232 - 233

Standard  
#1.1.012

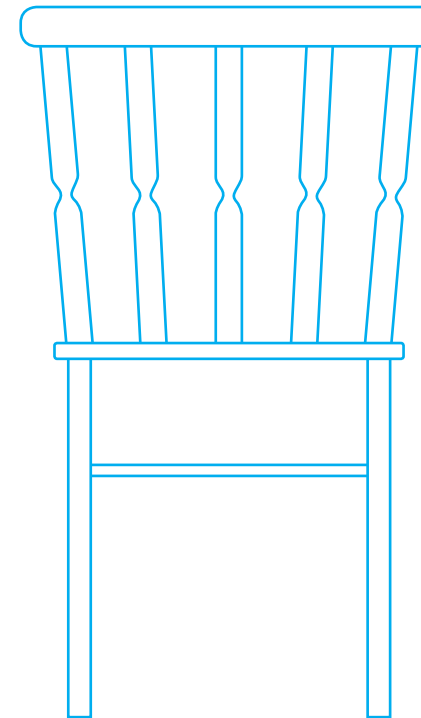

Alternativ  
#1.2.012+056

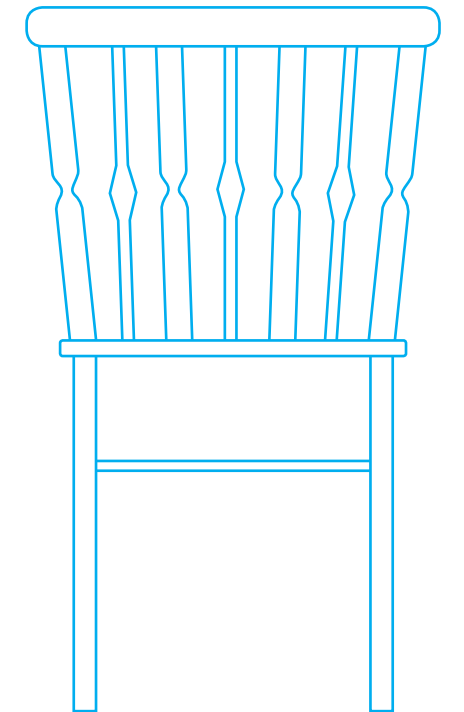

Produkten finns i flera utföranden, s. 6 - 7. (The product is available in several designs, p. 6 - 7.)



# 013

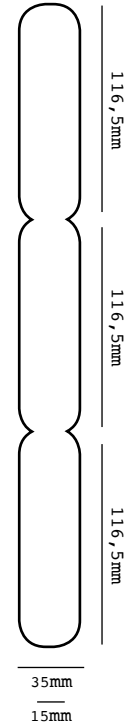

## PRODUKTFAKTA

**Pinnar** (spindles): 1-pack / 2-pack / 5-pack

**Material** (material): **Björk** (birch)

**Färgval** (colour): s. (p.) 232 - 233

Standard  
#1.1.013

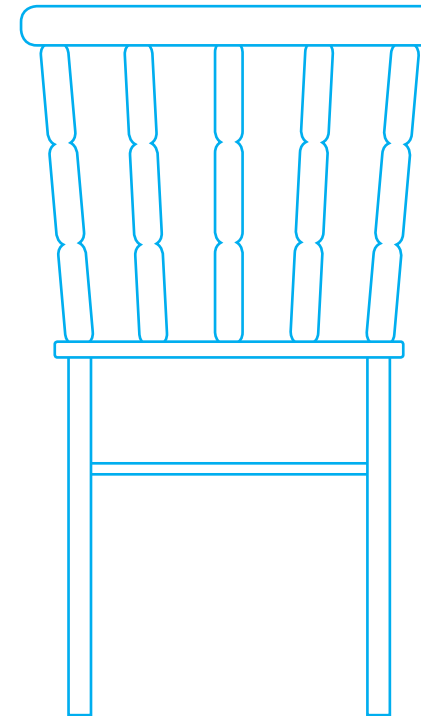

Alternativ  
#2.1.006+013

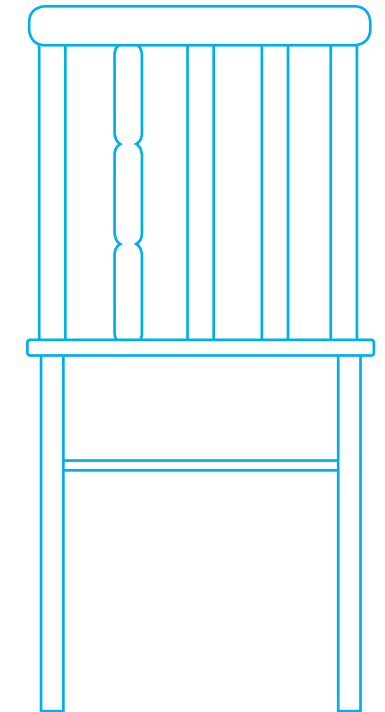

Produkten finns i flera utföranden, s. 6 - 7. (The product is available in several designs, p. 6 - 7.)



# 014

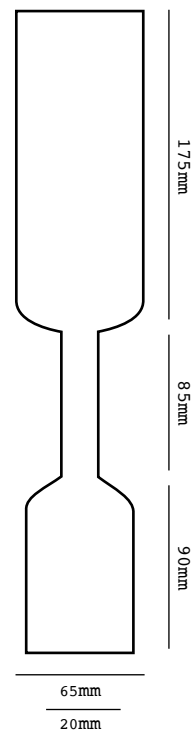

**PRODUKTFAKTA**

**Pinnar** (spindles): 1-pack / 2-pack / 5-pack

**Material** (material): Björk (birch)

**Färgval** (colour): s. (p.) 232 - 233

Standard  
#1.1.014

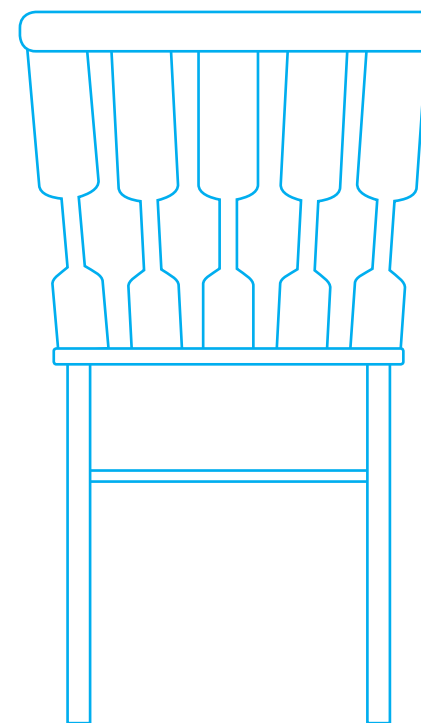

Alternativ  
#1.1.001 + 037

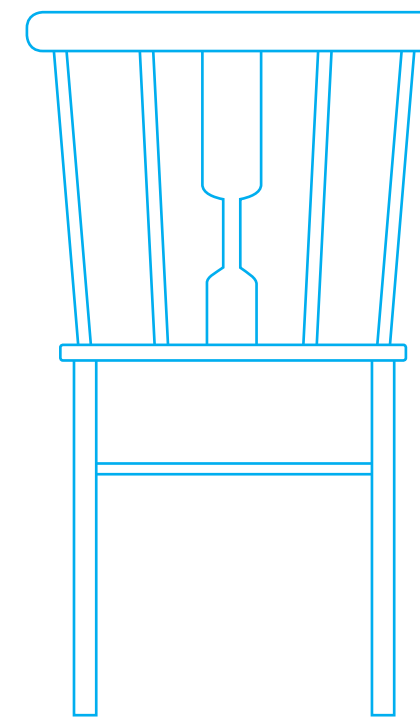

Produkten finns i flera utföranden, s. 6 - 7. (The product is available in several designs, p. 6 - 7.)



# 015

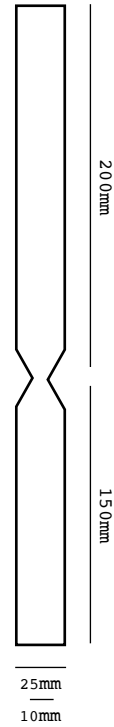

**PRODUKTFAKTA**

**Pinnar** (spindles): 1-pack / 2-pack / 5-pack

**Material** (material): **Björk** (birch)

**Färgval** (colour): s. (p.) 232 - 233

Standard  
#1.1.015

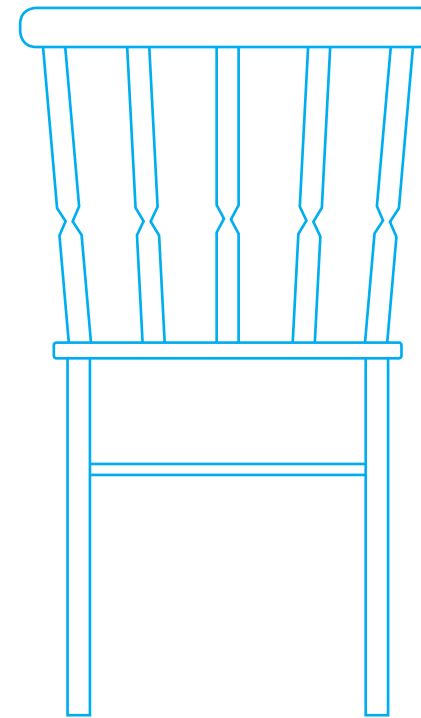

Alternativ  
#1.3.015

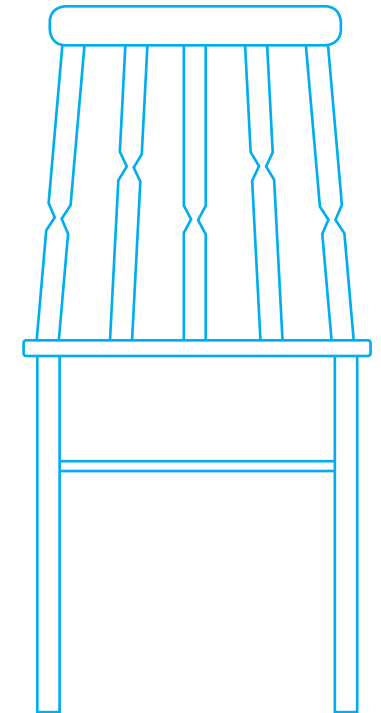

Produkten finns i flera utföranden, s. 6 - 7. (The product is available in several designs, p. 6 - 7.)



# 016

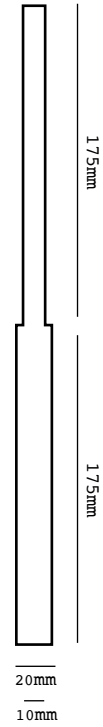

## PRODUKTFAKTA

**Pinnar** (spindles): 1-pack / 2-pack / 5-pack

**Material** (material): **Björk** (birch)

**Färgval** (colour): s. (p.) 232 - 233

Standard  
#1.1.016

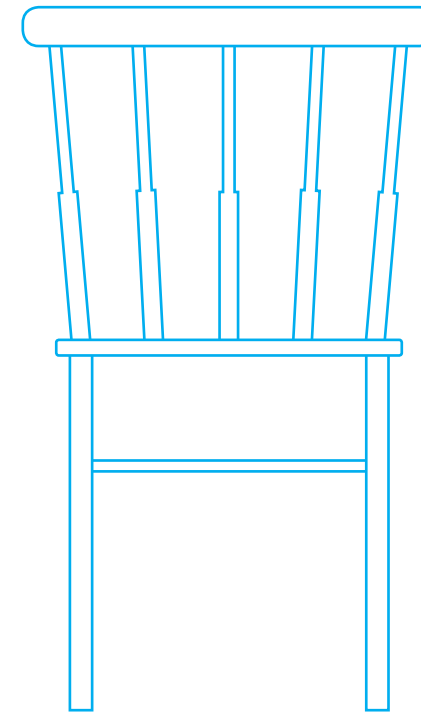

Alternativ  
#1.1.016

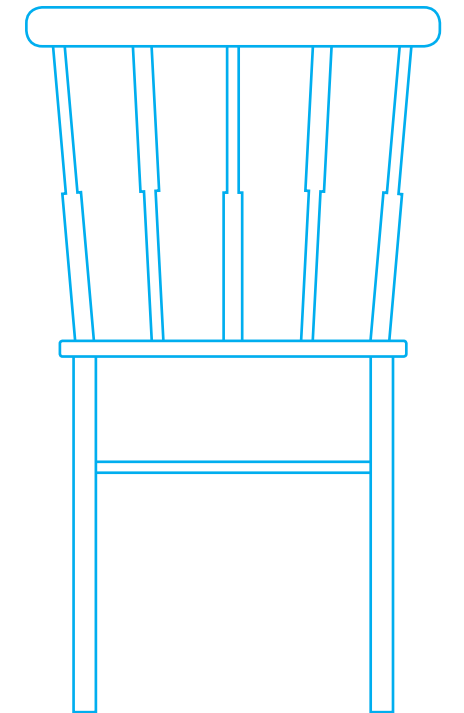

Produkten finns i flera utföranden, s. 6 - 7. (The product is available in several designs, p. 6 - 7.)



# 017



**PRODUKTFAKTA**

**Pinnar** (spindles): 1-pack / 2-pack / 5-pack

**Material** (material): **Björk** (birch)

**Färgval** (colour): s. (p.) 232 - 233

Standard  
#1.1.017

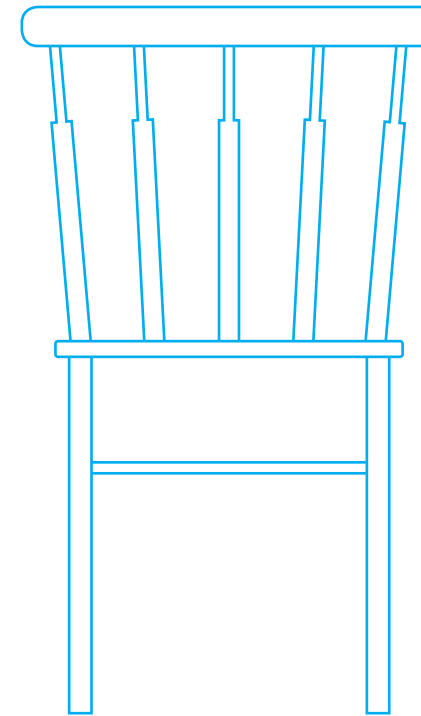

Alternativ  
#1.2.0016+0017

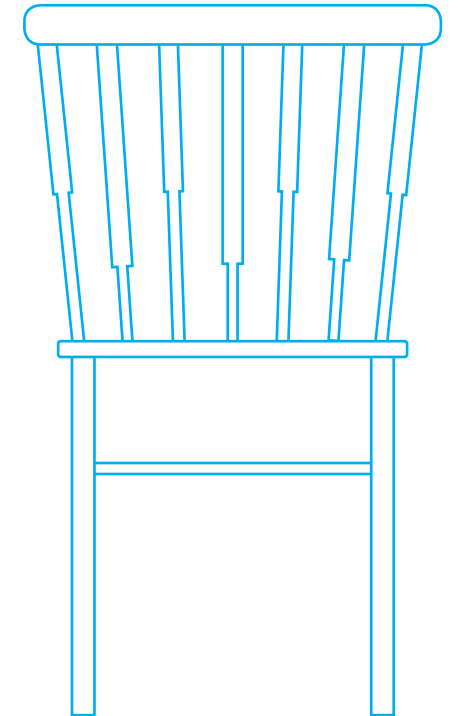

Produkten finns i flera utföranden, s. 6 - 7. (The product is available in several designs, p. 6 - 7.)

# 018

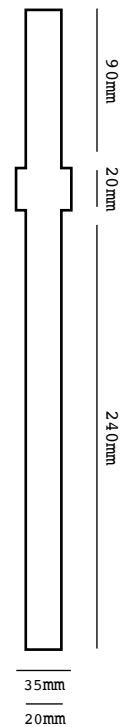

**PRODUKTFAKTA**

**Pinnar** (spindles): 1-pack / 2-pack / 5-pack

**Material** (material): **Björk** (birch)

**Färgval** (colour): s. (p.) 232 - 233

Standard  
#1.1.018

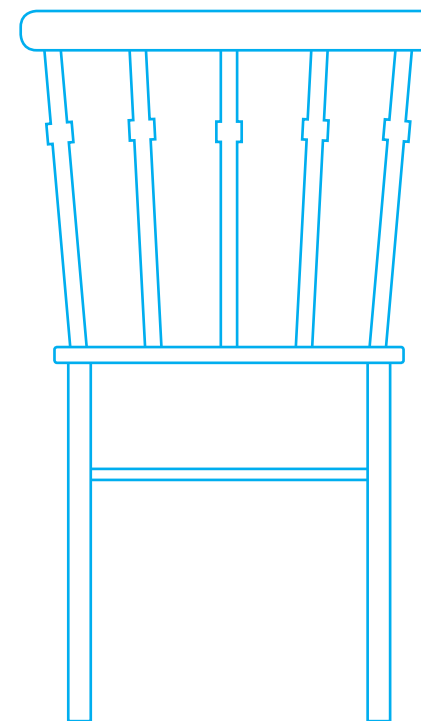

Alternativ  
#2.2.017+018

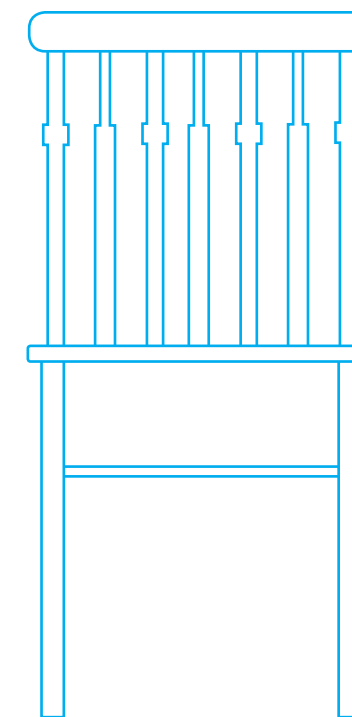

Produkten finns i flera utföranden, s. 6 - 7. (The product is available in several designs, p. 6 - 7.)



# 019

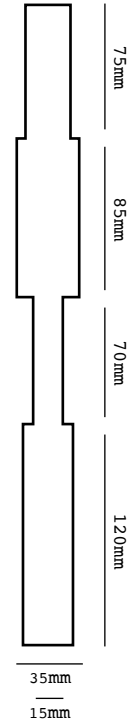

## PRODUKTFAKTA

**Pinnar** (spindles): 1-pack / 2-pack / 5-pack

**Material** (material): **Björk** (birch)

**Färgval** (colour): s. (p.) 232 - 233

Standard  
#1.1.019

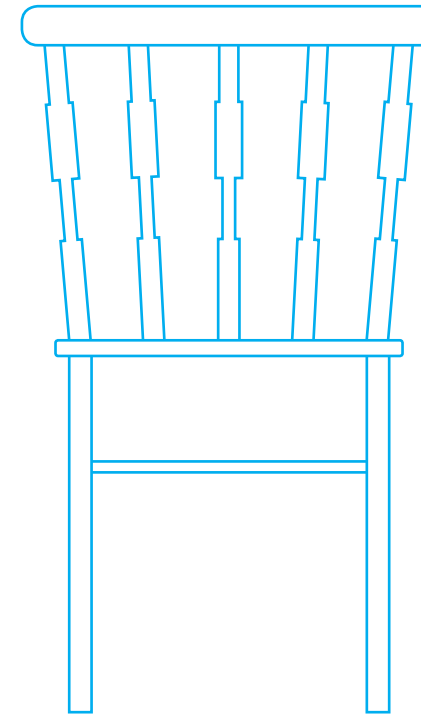

Alternativ  
#2.1.019

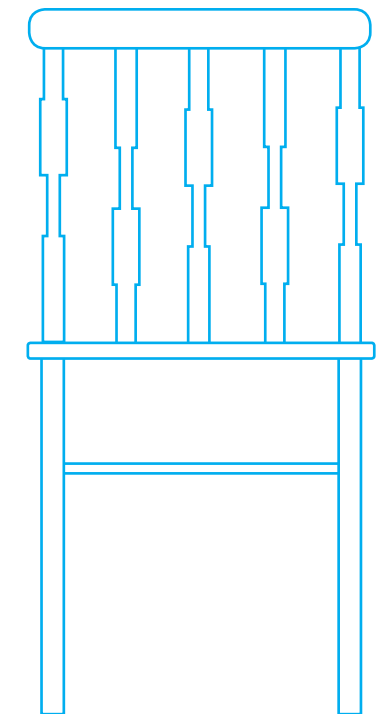

Produkten finns i flera utföranden, s. 6 - 7. (The product is available in several designs, p. 6 - 7.)





# 020

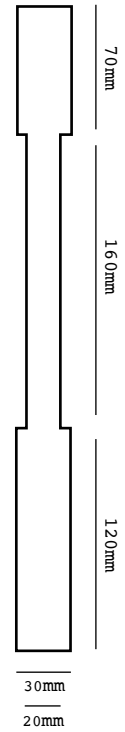

## PRODUKTFAKTA

**Pinnar** (spindles): 1-pack / 2-pack / 5-pack

**Material** (material): **Björk** (birch)

**Färgval** (colour): s. (p.) 232 - 233

Standard  
#1.1.020

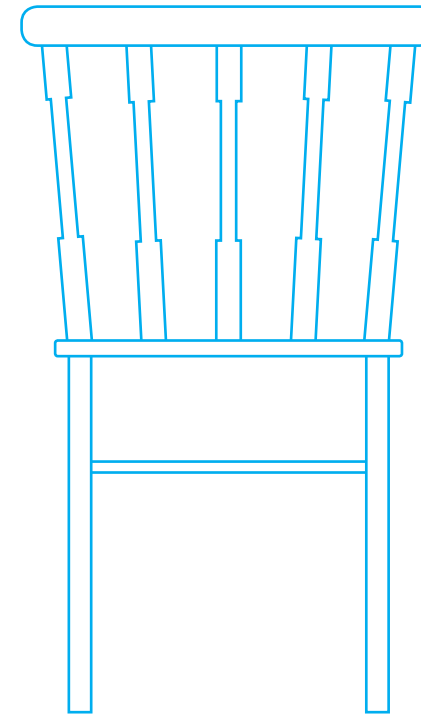

Alternativ  
#1.1.019+020

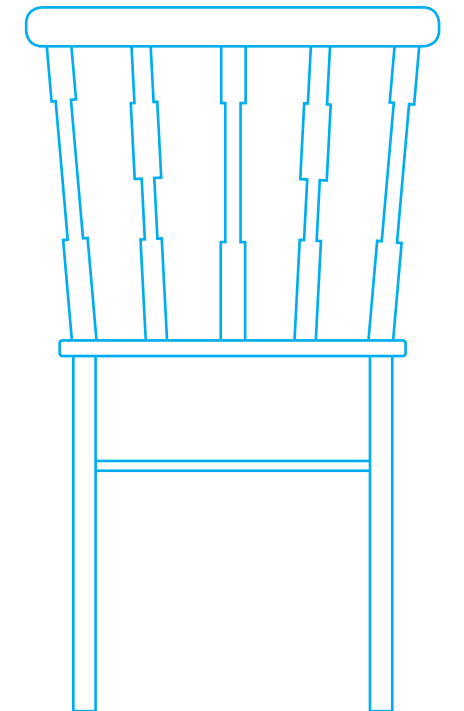

Produkten finns i flera utföranden, s. 6 - 7. (The product is available in several designs, p. 6 - 7.)



# 021

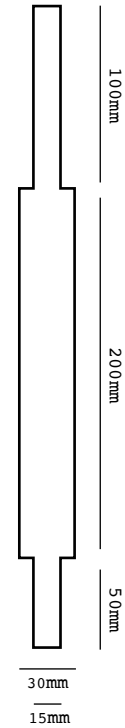

## PRODUKTFAKTA

**Pinnar** (spindles): 1-pack / 2-pack / 5-pack

**Material** (material): **Björk** (birch)

**Färgval** (colour): s. (p.) 232 - 233

Standard  
#1.1.021

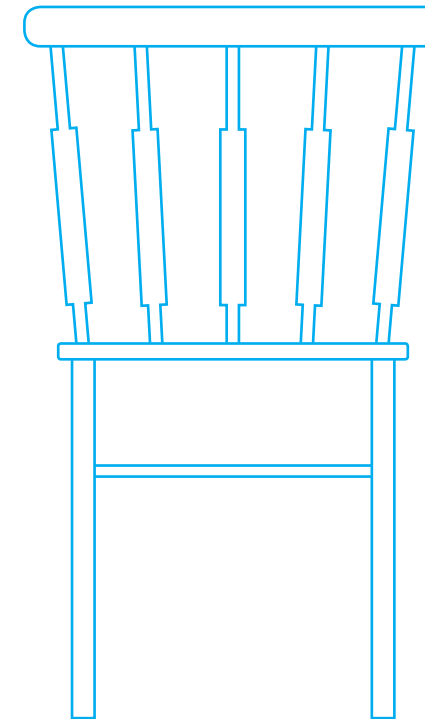

Alternativ  
#2.1.021+033

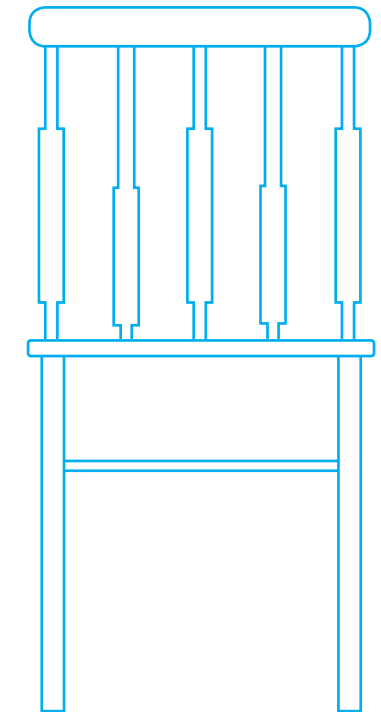

Produkten finns i flera utföranden, s. 6 - 7. (The product is available in several designs, p. 6 - 7.)

# 022

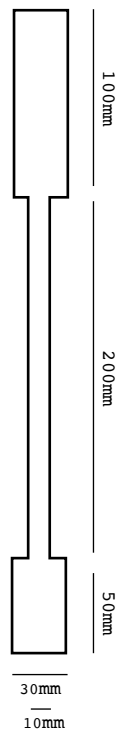

## PRODUKTFAKTA

**Pinnar** (spindles): 1-pack / 2-pack / 5-pack

**Material** (material): **Björk** (birch)

**Färgval** (colour): s. (p.) 232 - 233

Standard  
#1.1.022

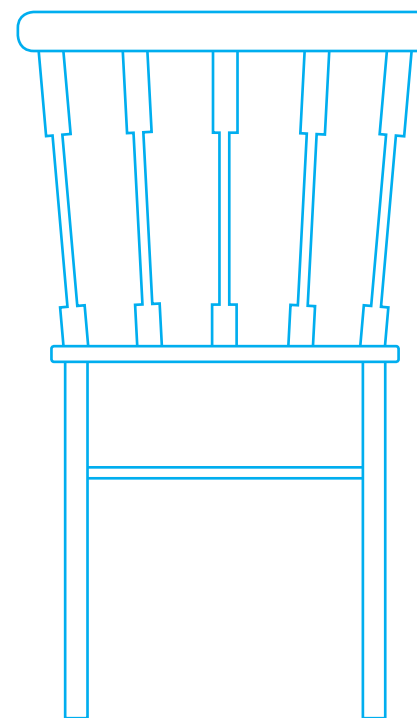

Alternativ  
#1.1.021+022

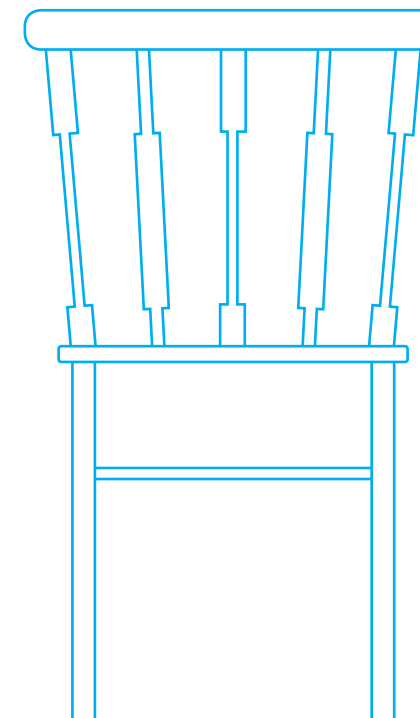

Produkten finns i flera utföranden, s. 6 - 7. (The product is available in several designs, p. 6 - 7.)

# 023

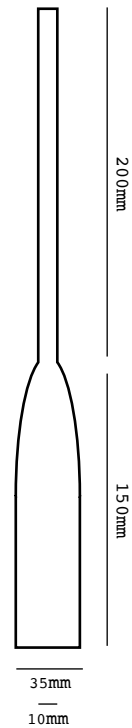

**PRODUKTFAKTA**

**Pinnar** (spindles): 1-pack / 2-pack / 5-pack

**Material** (material): **Björk** (birch)

**Färgval** (colour): s. (p.) 232 - 233

Standard  
#1.1.023

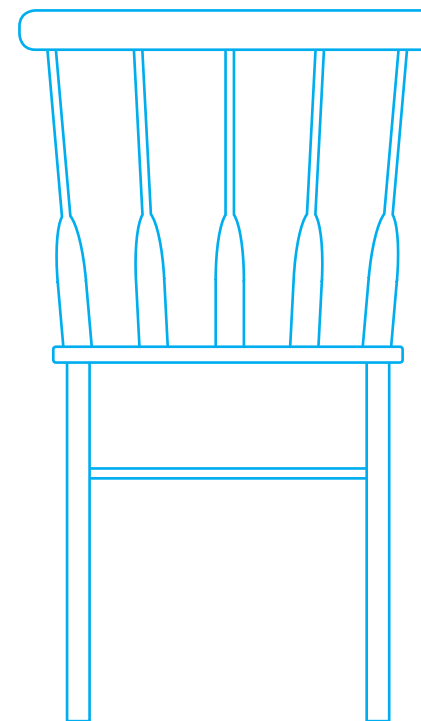

Alternativ  
#1.1.011+023

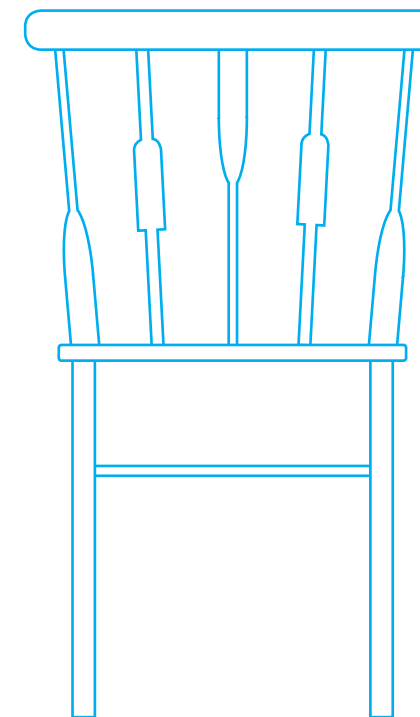

Produkten finns i flera utföranden, s. 6 - 7. (The product is available in several designs, p. 6 - 7.)



# 024

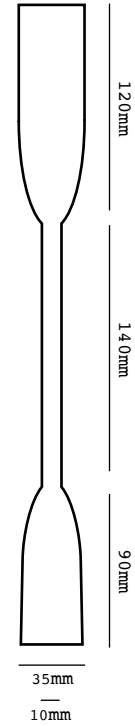

## PRODUKTFAKTA

**Pinnar** (spindles): 1-pack / 2-pack / 5-pack

**Material** (material): **Björk** (birch)

**Färgval** (colour): s. (p.) 232 - 233

Standard  
#1.1.024

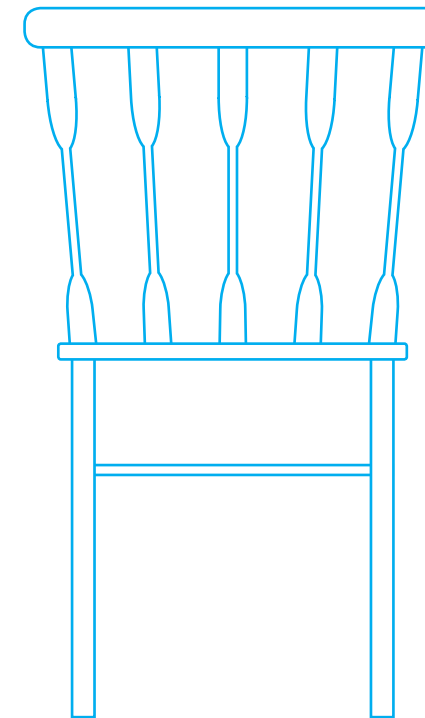

Alternativ  
#1.1.023+024

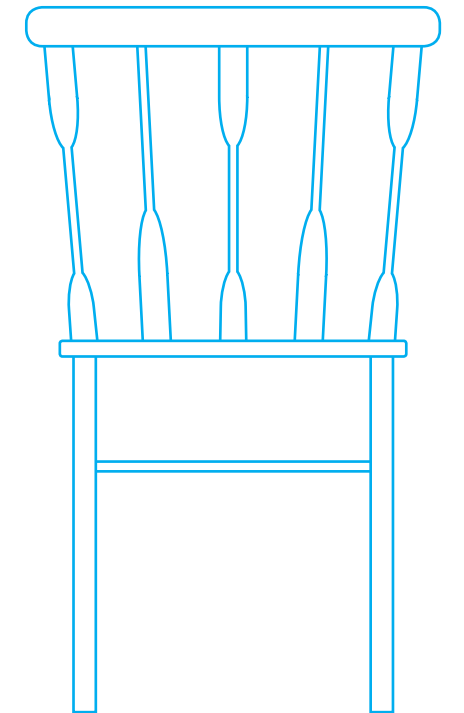

Produkten finns i flera utföranden, s. 6 - 7. (The product is available in several designs, p. 6 - 7.)



# 025

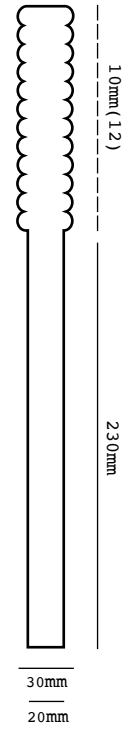

**PRODUKTFAKTA**

**Pinnar** (spindles): 1-pack / 2-pack / 5-pack

**Material** (material): **Björk** (birch)

**Färgval** (colour): s. (p.) 232 - 233

Standard  
#1.1.025

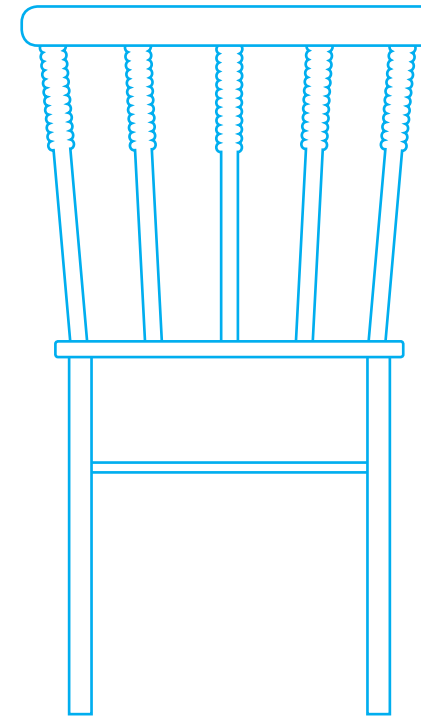

Alternativ  
#1.3.003.+025

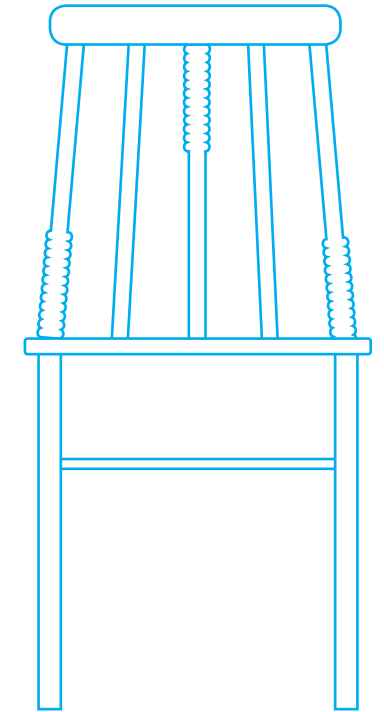

Produkten finns i flera utföranden, s. 6 - 7. (The product is available in several designs, p. 6 - 7.)

# 026

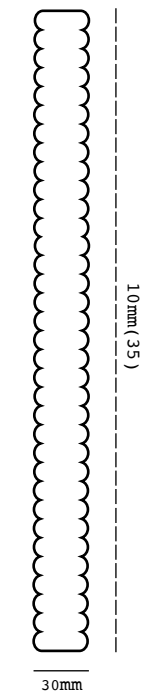

**PRODUKTFAKTA**

**Pinnar** (spindles): 1-pack / 2-pack / 5-pack

**Material** (material): **Björk** (birch)

**Färgval** (colour): s. (p.) 232 - 233

Standard  
#1.1.026

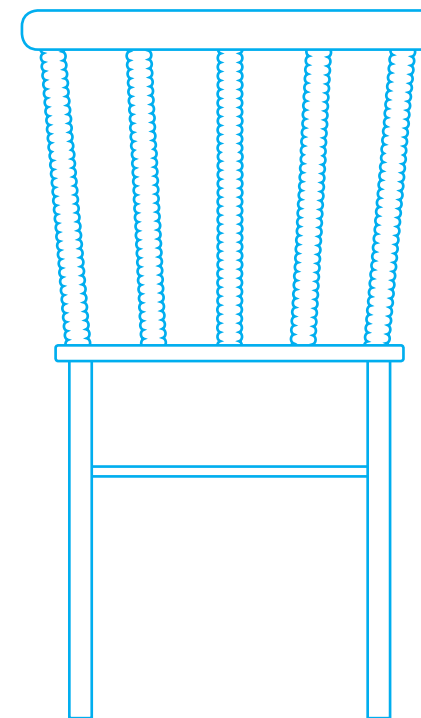

Alternativ  
#2.1.025+026

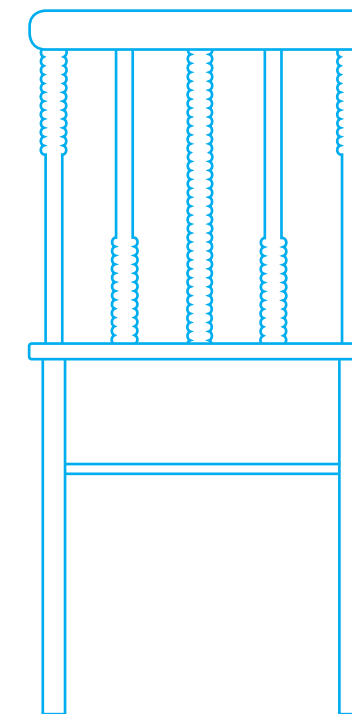

Produkten finns i flera utföranden, s. 6 - 7. (The product is available in several designs, p. 6 - 7.)



# 027

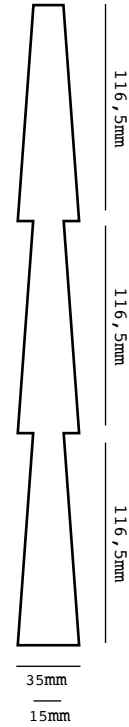

**PRODUKTFAKTA**

**Pinnar** (spindles): 1-pack / 2-pack / 5-pack

**Material** (material): **Björk** (birch)

**Färgval** (colour): s. (p.) 232 - 233

Standard  
#1.1.027

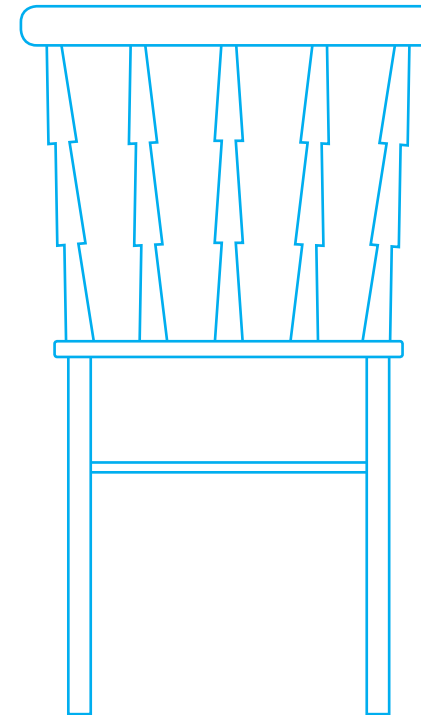

Alternativ  
#2.2.027

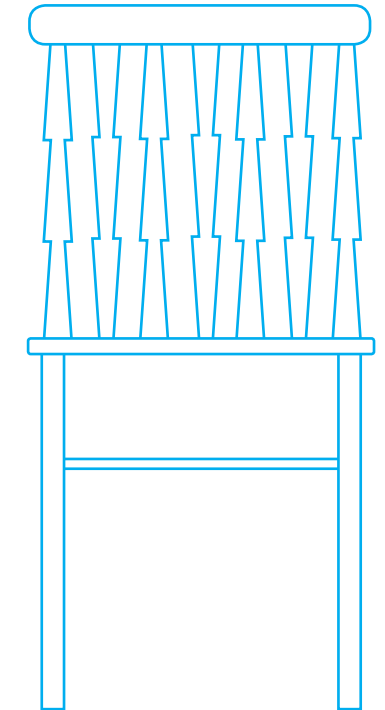

Produkten finns i flera utföranden, s. 6 - 7. (The product is available in several designs, p. 6 - 7.)





# 028

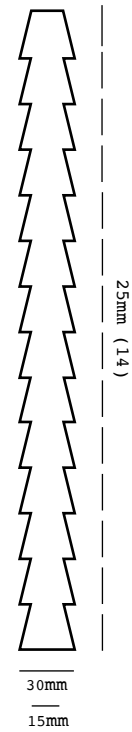

**PRODUKTFAKTA**

**Pinnar** (spindles): 1-pack / 2-pack / 5-pack

**Material** (material): **Björk** (birch)

**Färgval** (colour): s. (p.) 232 - 233

Standard  
#1.1.028

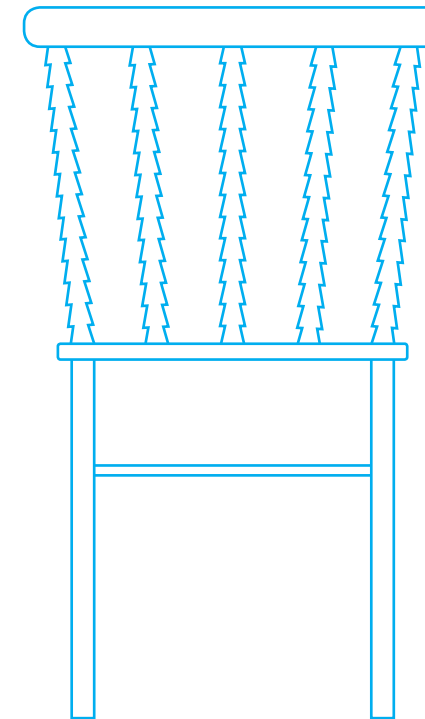

Alternativ  
#1.1.003+028

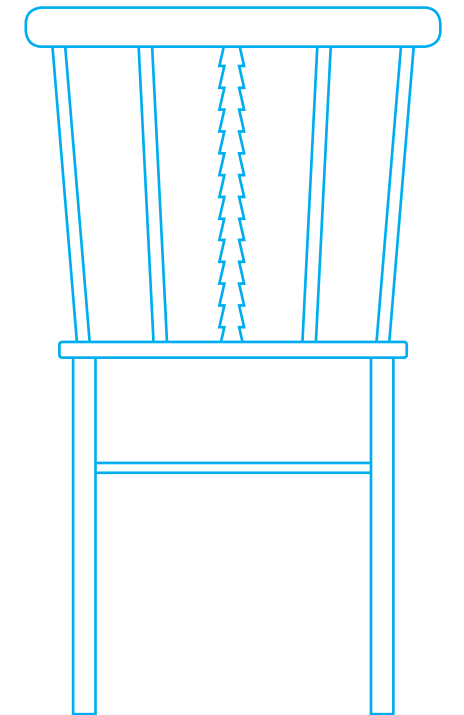

Produkten finns i flera utföranden, s. 6 - 7. (The product is available in several designs, p. 6 - 7.)



# 029

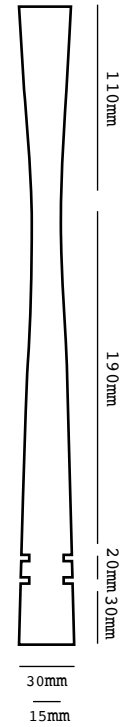

## PRODUKTFAKTA

**Pinnar** (spindles): 1-pack / 2-pack / 5-pack

**Material** (material): **Björk** (birch)

**Färgval** (colour): s. (p.) 232 - 233

Standard  
#1.1.029

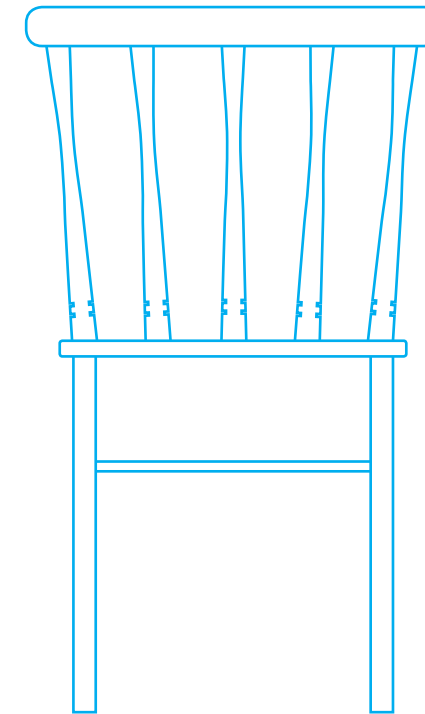

Alternativ  
#1.3.029

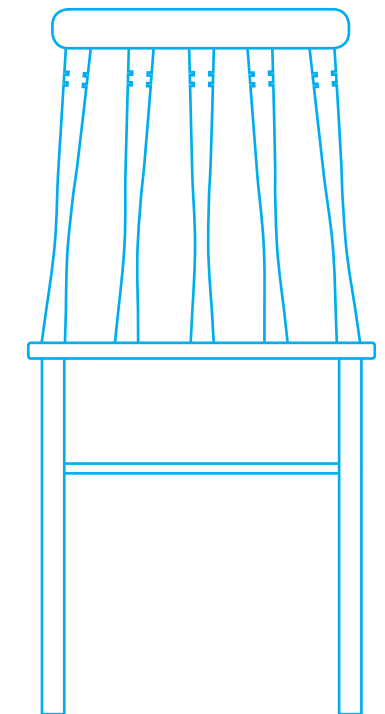

Produkten finns i flera utföranden, s. 6 - 7. (The product is available in several designs, p. 6 - 7.)

# 030

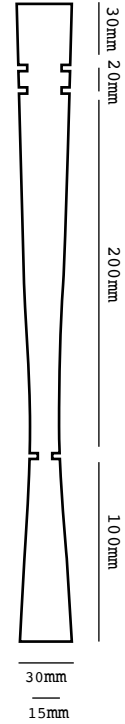

## PRODUKTFAKTA

**Pinnar** (spindles): 1-pack / 2-pack / 5-pack

**Material** (material): **Björk** (birch)

**Färgval** (colour): s. (p.) 232 - 233

Standard  
#1.1.030

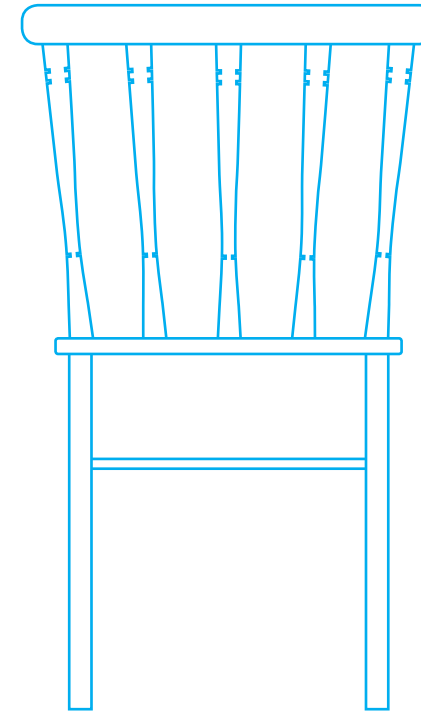

Alternativ  
#1.1.029+030

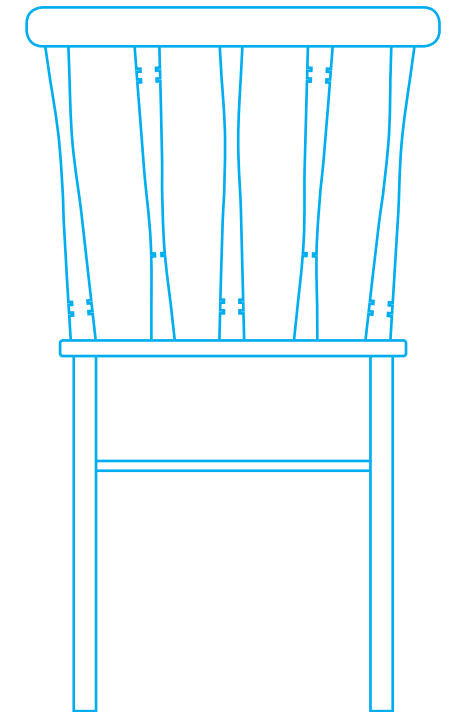

Produkten finns i flera utföranden, s. 6 - 7. (The product is available in several designs, p. 6 - 7.)









# 031

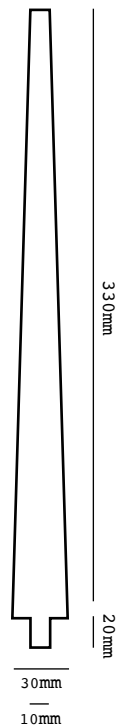

## PRODUKTFAKTA

**Pinnar** (spindles): 1-pack / 2-pack / 5-pack

**Material** (material): **Björk** (birch)

**Färgval** (colour): s. (p.) 232 - 233

Standard  
#1.1.031

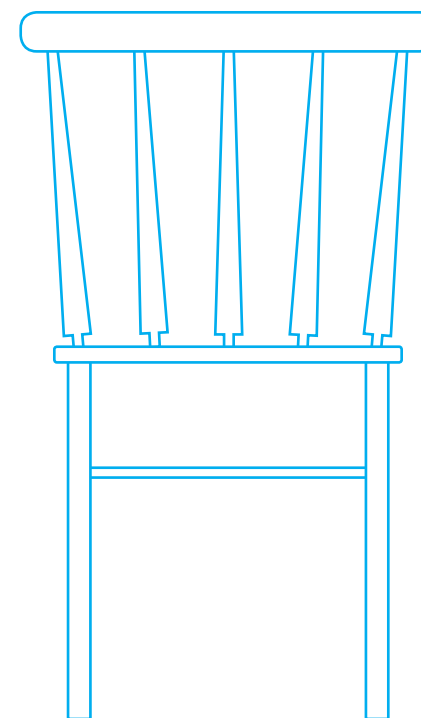

Alternativ  
#2.2.031

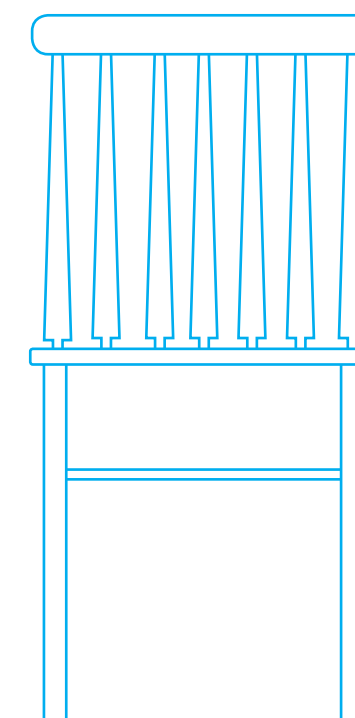

Produkten finns i flera utföranden, s. 6 - 7. (The product is available in several designs, p. 6 - 7.)



# 032

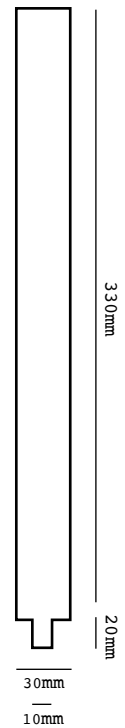

**PRODUKTFAKTA**

**Pinnar** (spindles): 1-pack / 2-pack / 5-pack

**Material** (material): **Björk** (birch)

**Färgval** (colour): s. (p.) 232 - 233

Standard  
#1.1.032

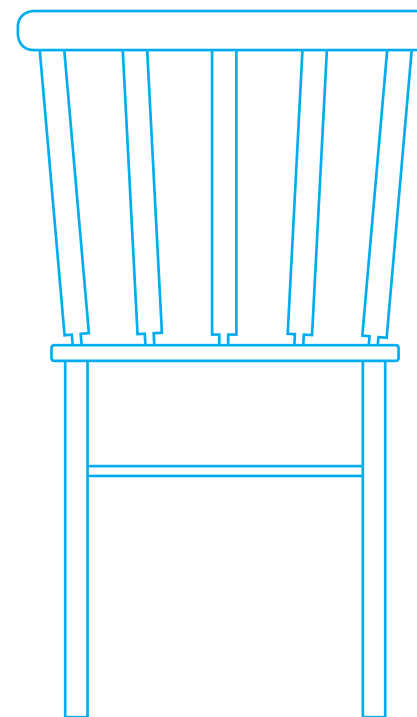

Alternativ  
#2.1.032

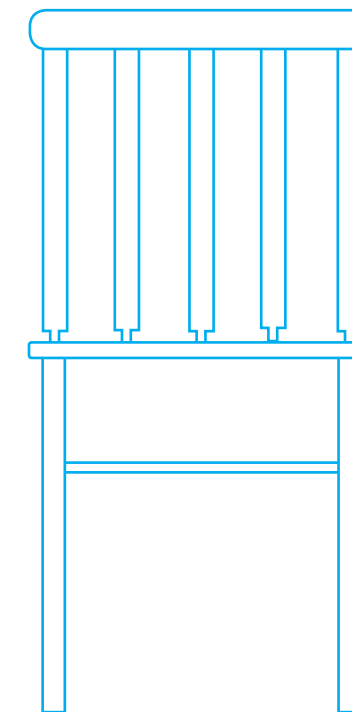

Produkten finns i flera utföranden, s. 6 - 7. (The product is available in several designs, p. 6 - 7.)



# 033

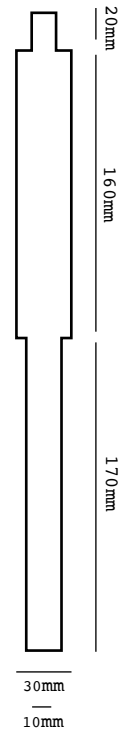

**PRODUKTFAKTA**

**Pinnar** (spindles): 1-pack / 2-pack / 5-pack

**Material** (material): **Björk** (birch)

**Färgval** (colour): s. (p.) 232 - 233

Standard  
#1.1.033

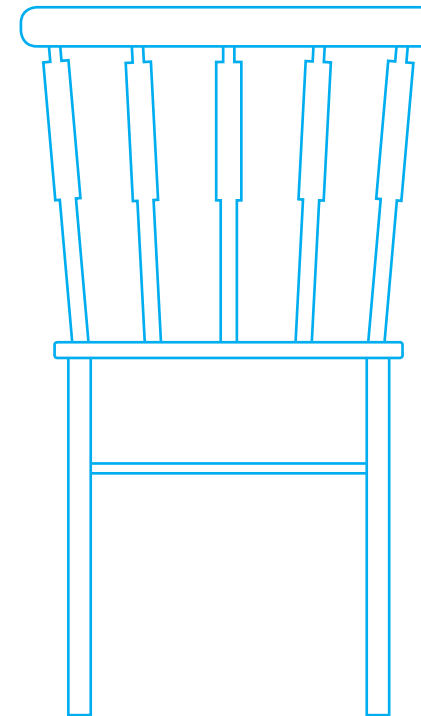

Alternativ  
#1.1.032+033

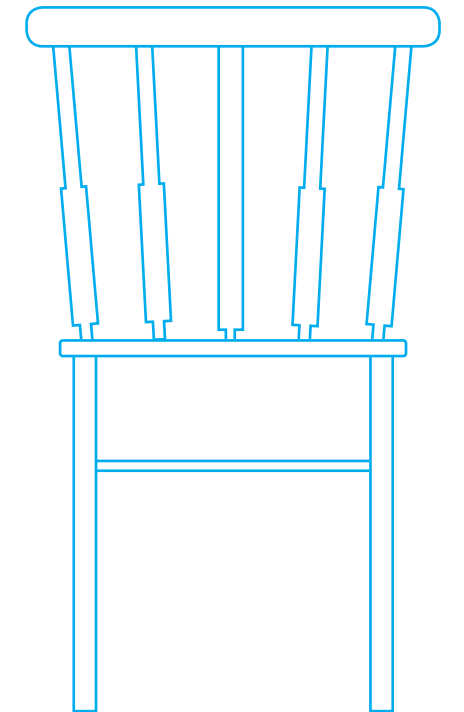

Produkten finns i flera utföranden, s. 6 - 7. (The product is available in several designs, p. 6 - 7.)

# 034

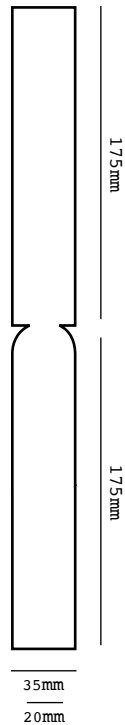

## PRODUKTFAKTA

**Pinnar** (spindles): 1-pack / 2-pack / 5-pack

**Material** (material): Björk (birch)

**Färgval** (colour): s. (p.) 232 - 233

Standard  
#1.1.034

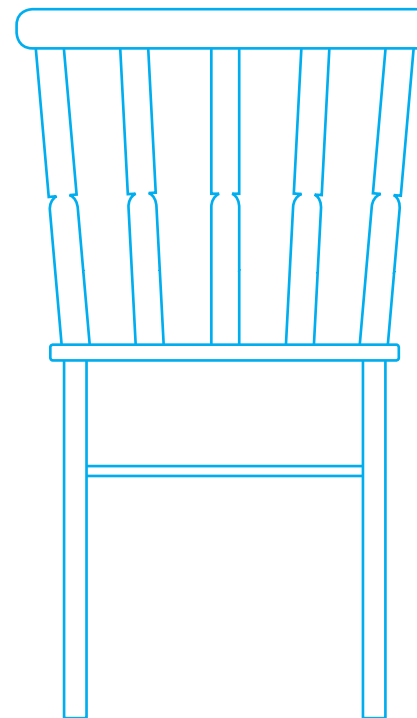

Alternativ  
#1.1.034+035

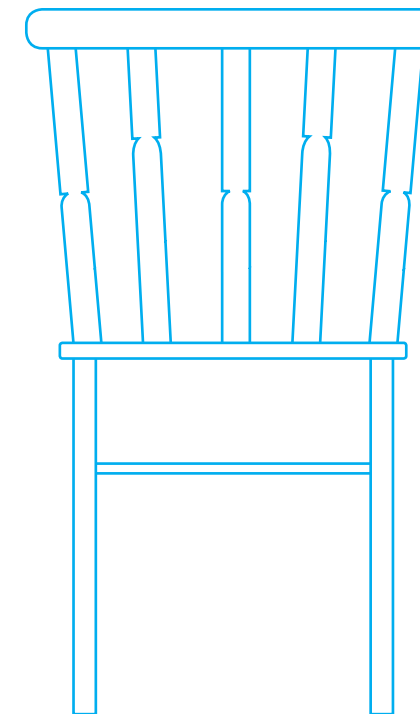

Produkten finns i flera utföranden, s. 6 - 7. (The product is available in several designs, p. 6 - 7.)



# 035

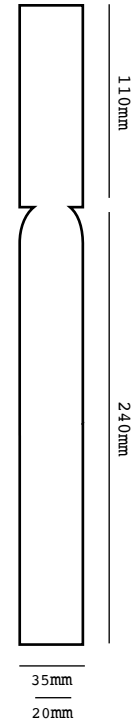

**PRODUKTFAKTA**

**Pinnar** (spindles): 1-pack / 2-pack / 5-pack

**Material** (material): **Björk** (birch)

**Färgval** (colour): s. (p.) 232 - 233

Standard  
#1.1.035

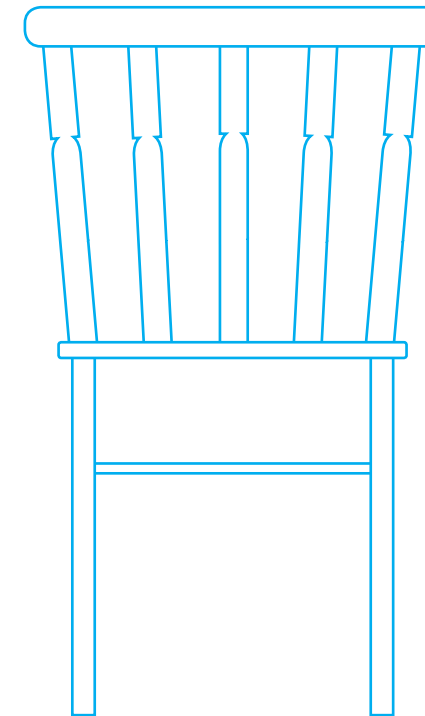

Alternativ  
#2.2.011+035

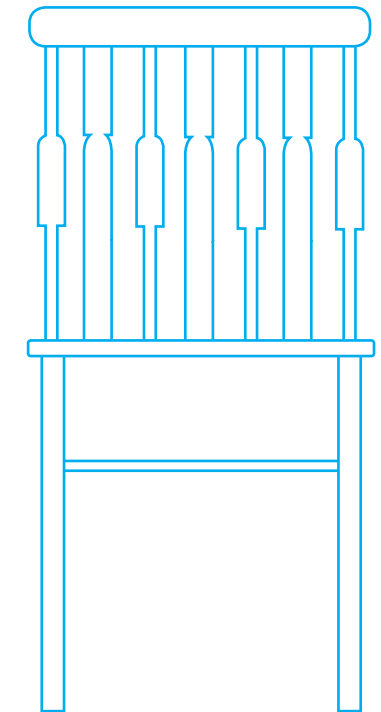

Produkten finns i flera utföranden, s. 6 - 7. (The product is available in several designs, p. 6 - 7.)



# 036

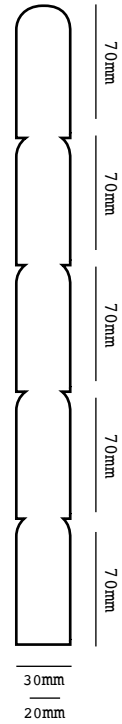

## PRODUKTFAKTA

**Pinnar** (spindles): 1-pack / 2-pack / 5-pack

**Material** (material): **Björk** (birch)

**Färgval** (colour): s. (p.) 232 - 233

Standard  
#1.1.036

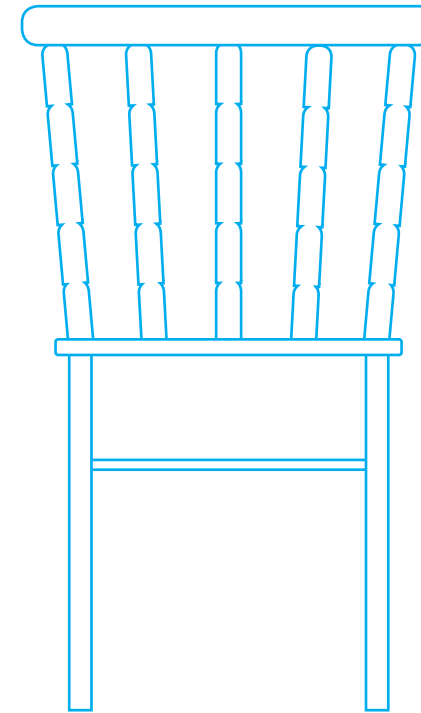

Alternativ  
#1.2.036

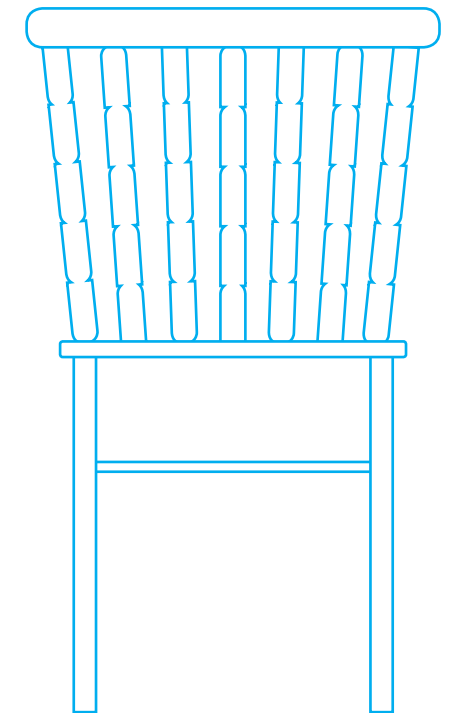

Produkten finns i flera utföranden, s. 6 - 7. (The product is available in several designs, p. 6 - 7.)



# 037

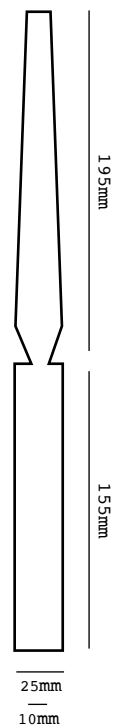

**PRODUKTFAKTA**

**Pinnar** (spindles): 1-pack / 2-pack / 5-pack

**Material** (material): **Björk** (birch)

**Färgval** (colour): s. (p.) 232 - 233

Standard  
#1.1.037

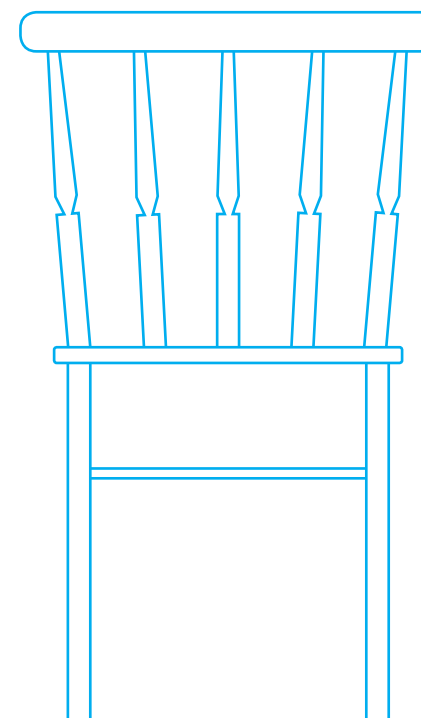

Alternativ  
#1.2.037+038

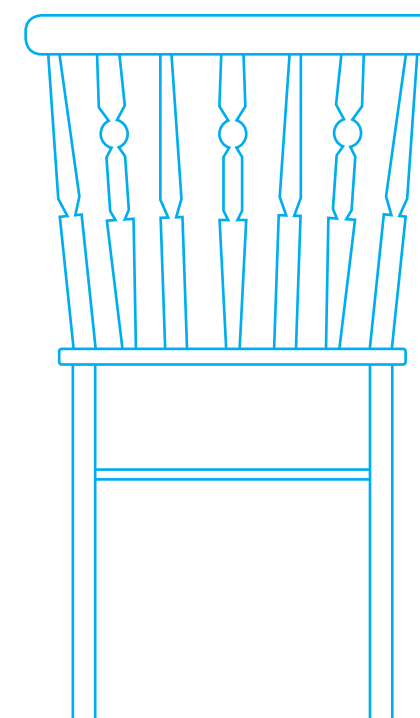

Produkten finns i flera utföranden, s. 6 - 7. (The product is available in several designs, p. 6 - 7.)



# 038

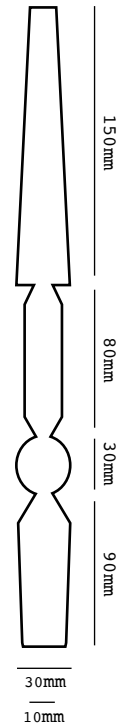

#### PRODUKTFAKTA

**Pinnar** (spindles): 1-pack / 2-pack / 5-pack

**Material** (material): **Björk** (birch)

**Färgval** (colour): s. (p.) 232 - 233

Standard  
#1.1.038

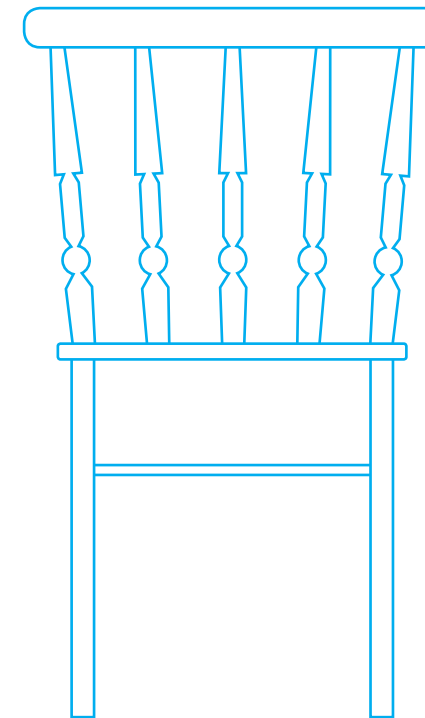

Alternativ  
#1.1.038+054

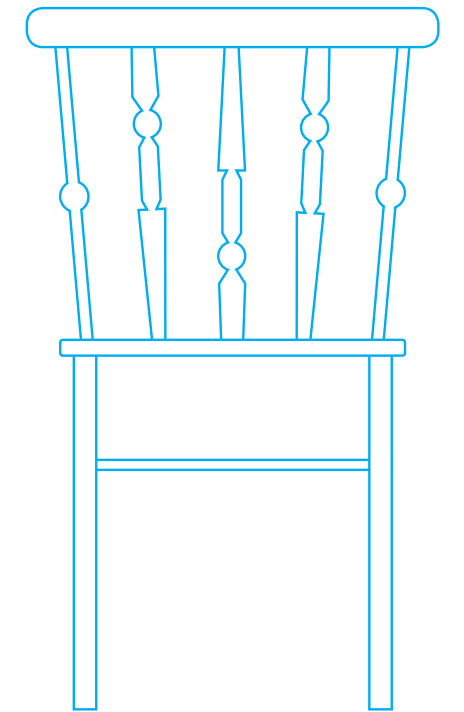

Produkten finns i flera utföranden, s. 6 - 7. (The product is available in several designs, p. 6 - 7.)



# 039

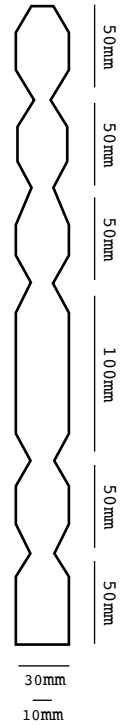

**PRODUKTFAKTA**

**Pinnar** (spindles): 1-pack / 2-pack / 5-pack

**Material** (material): **Björk** (birch)

**Färgval** (colour): s. (p.) 232 - 233

Standard  
#1.1.039

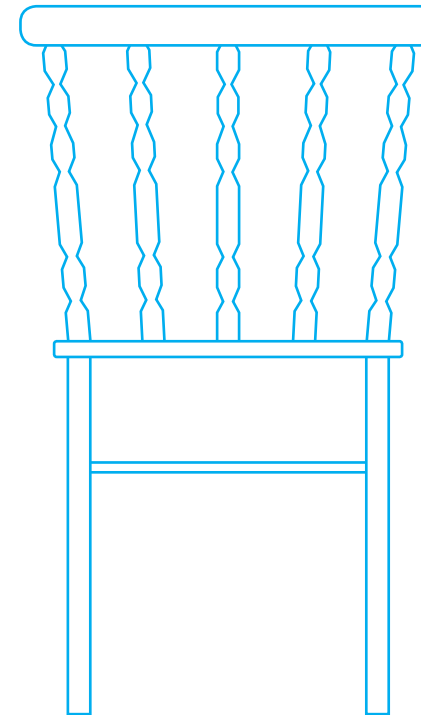

Alternativ  
#1.2.005+039

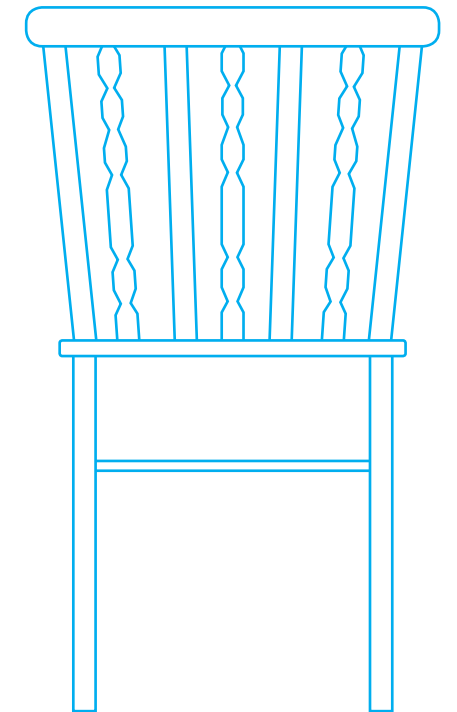

Produkten finns i flera utföranden, s. 6 - 7. (The product is available in several designs, p. 6 - 7.)





# 040

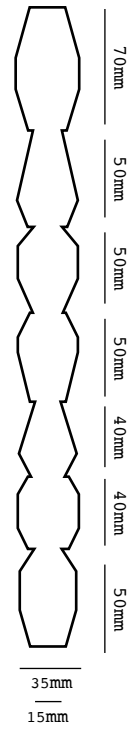

## PRODUKTFAKTA

**Pinnar (spindles):** 1-pack / 2-pack / 5-pack

**Material (material):** Björk (birch)

**Färgval (colour):** s. (p.) 232 - 233

Standard  
#1.1.040

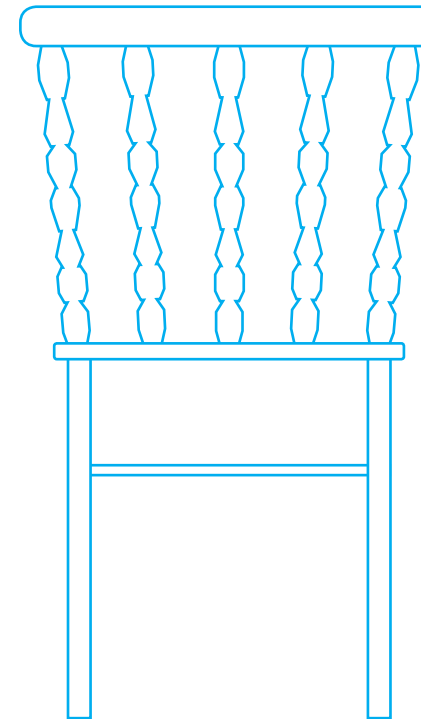

Alternativ  
#1.3.040

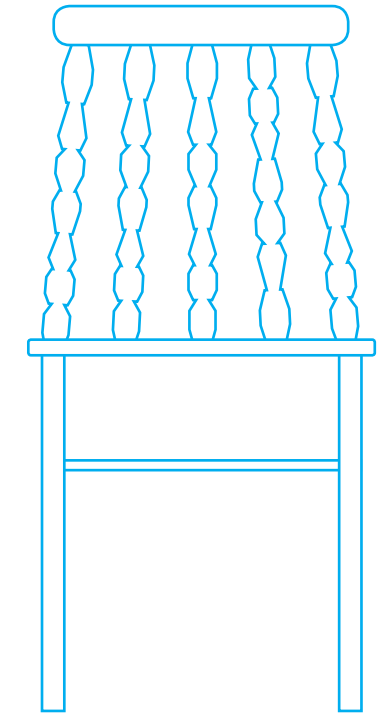

Produkten finns i flera utföranden, s. 6 - 7. (The product is available in several designs, p. 6 - 7.)



# 041

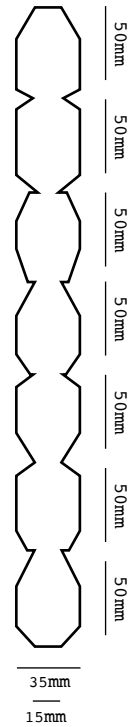

## PRODUKTFAKTA

**Pinnar** (spindles): 1-pack / 2-pack / 5-pack

**Material** (material): **Björk** (birch)

**Färgval** (colour): s. (p.) 232 - 233

Standard  
#1.1.041

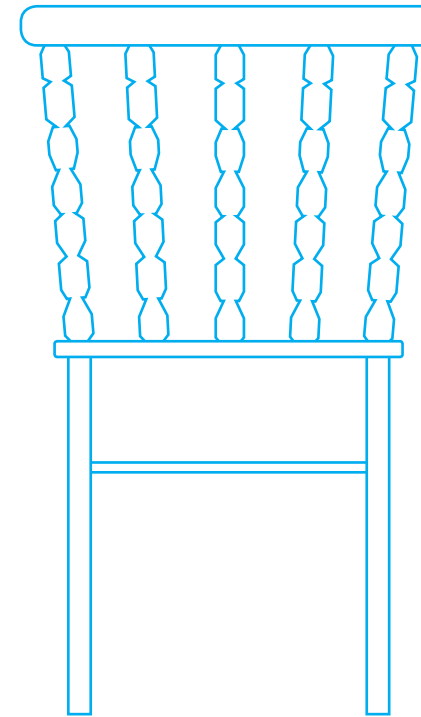

Alternativ  
#2.1.040+041

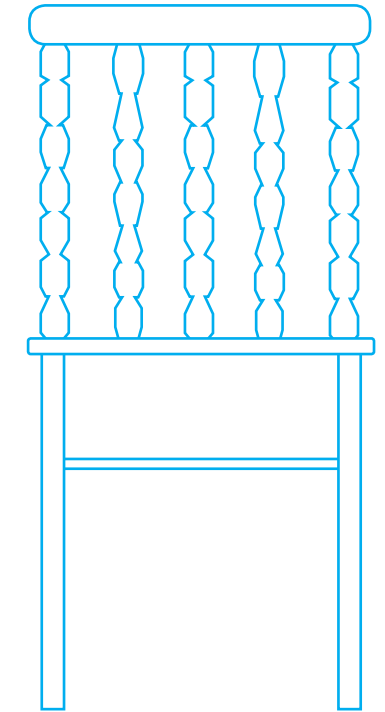

Produkten finns i flera utföranden, s. 6 - 7. (The product is available in several designs, p. 6 - 7.)

***Duon Stapla***  
*(The stack duo)*





# 042

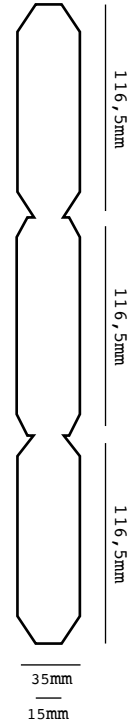

**PRODUKTFAKTA**

**Pinnar** (spindles): 1-pack / 2-pack / 5-pack

**Material** (material): **Björk** (birch)

**Färgval** (colour): s. (p.) 232 - 233

Standard  
#1.1.042

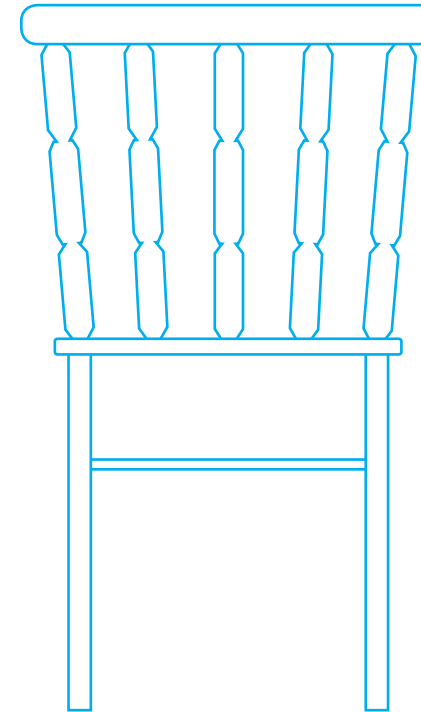

Alternativ  
#1.1.040+041+042

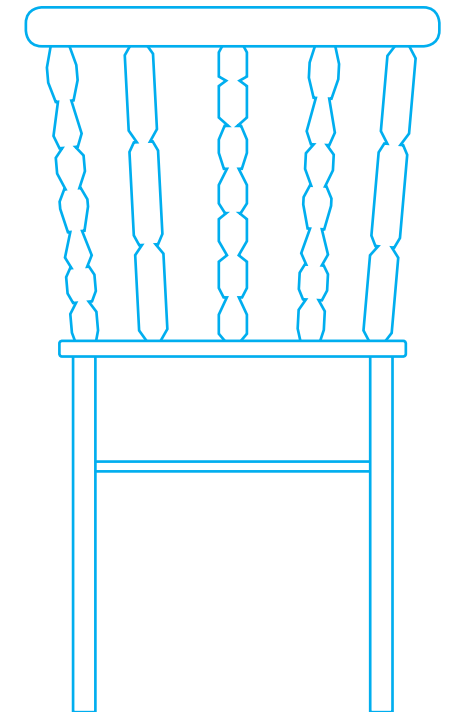

Produkten finns i flera utföranden, s. 6 - 7. (The product is available in several designs, p. 6 - 7.)



# 043

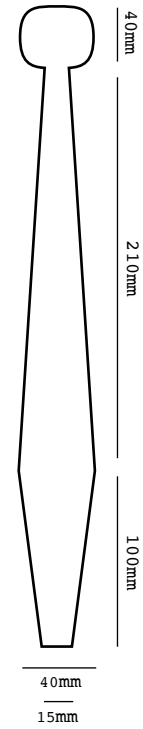

**PRODUKTFAKTA**

**Pinnar** (spindles): 1-pack / 2-pack / 5-pack

**Material** (material): **Björk** (birch)

**Färgval** (colour): s. (p.) 232 - 233

Standard  
#1.1.043

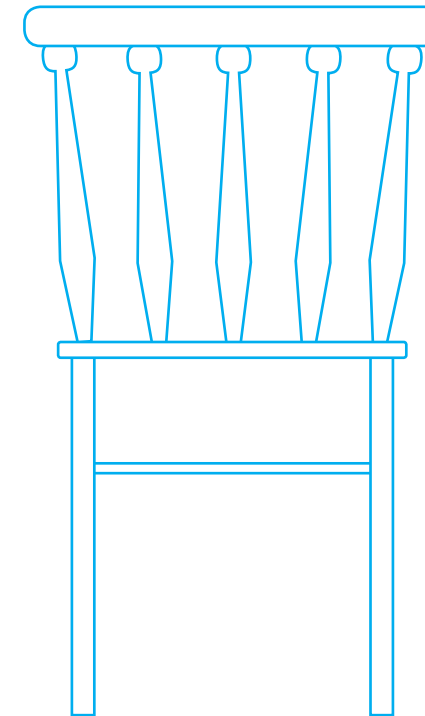

Alternativ  
#1.1.043+044

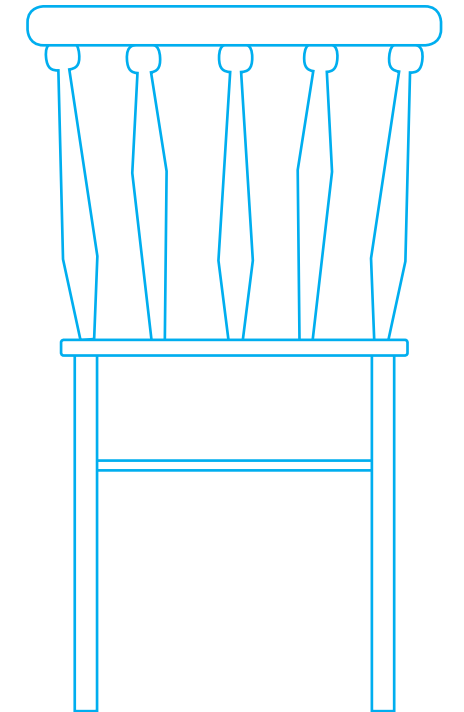

Produkten finns i flera utföranden, s. 6 - 7. (The product is available in several designs, p. 6 - 7.)



# 044

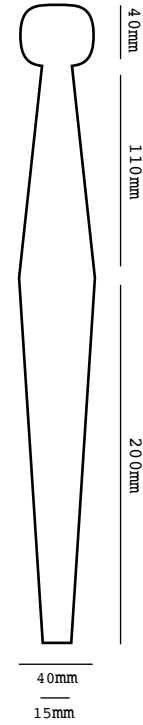

**PRODUKTFAKTA**

**Pinnar** (spindles): 1-pack / 2-pack / 5-pack

**Material** (material): **Björk** (birch)

**Färgval** (colour): s. (p.) 232 - 233

Standard  
#1.1.044

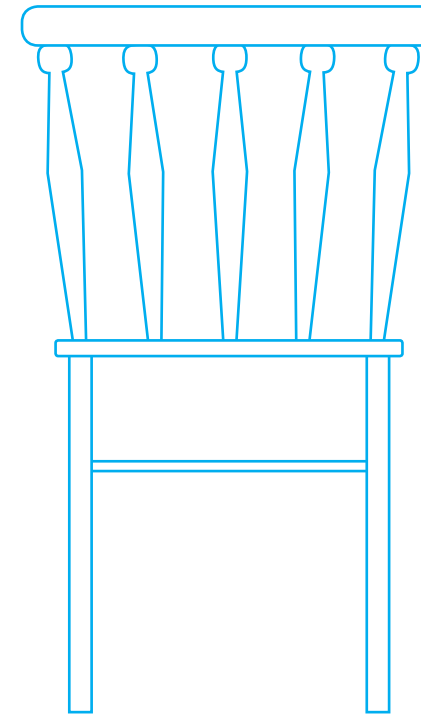

Alternativ  
#1.1.043+044+045

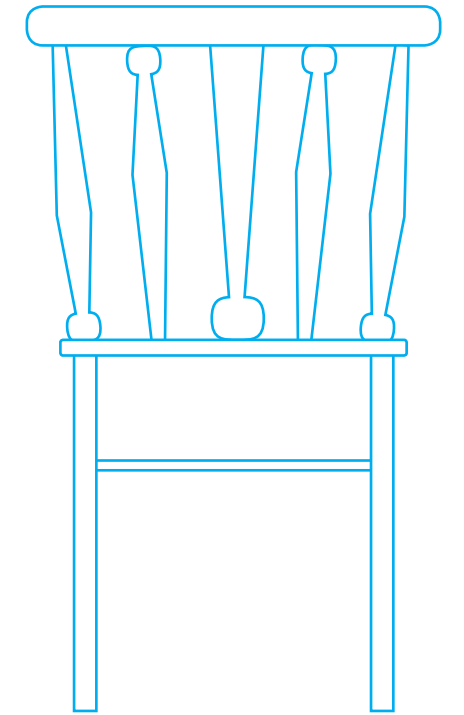

Produkten finns i flera utföranden, s. 6 - 7. (The product is available in several designs, p. 6 - 7.)



# 045

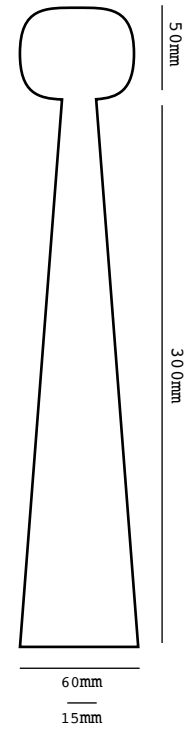

**PRODUKTFAKTA**

**Pinnar** (spindles): 1-pack / 2-pack / 5-pack

**Material** (material): **Björk** (birch)

**Färgval** (colour): s. (p.) 232 - 233

Standard  
#1.1.045

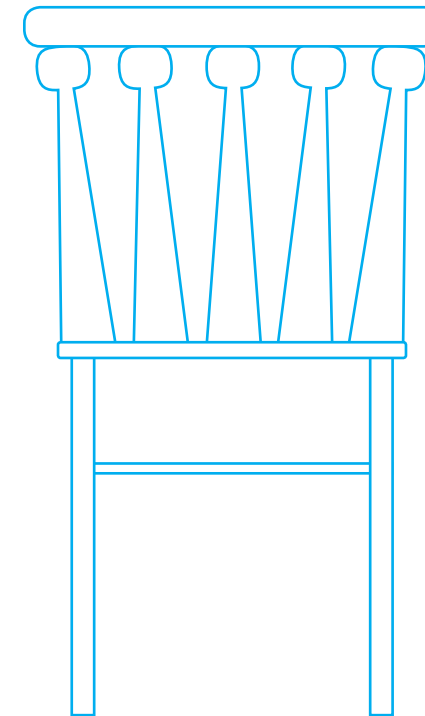

Alternativ  
#1.3.008+045

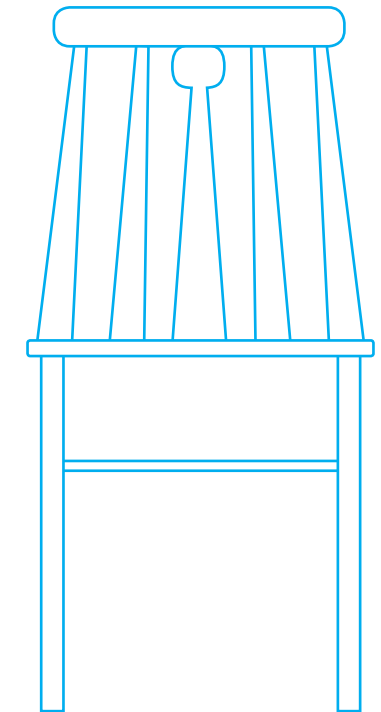

Produkten finns i flera utföranden, s. 6 - 7. (The product is available in several designs, p. 6 - 7.)



# 046

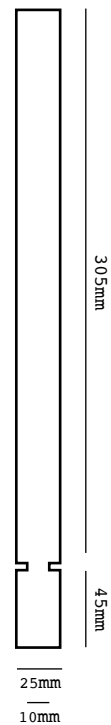

## PRODUKTFAKTA

**Pinnar** (spindles): 1-pack / 2-pack / 5-pack

**Material** (material): **Björk** (birch)

**Färgval** (colour): s. (p.) 232 - 233

Standard  
#1.1.046

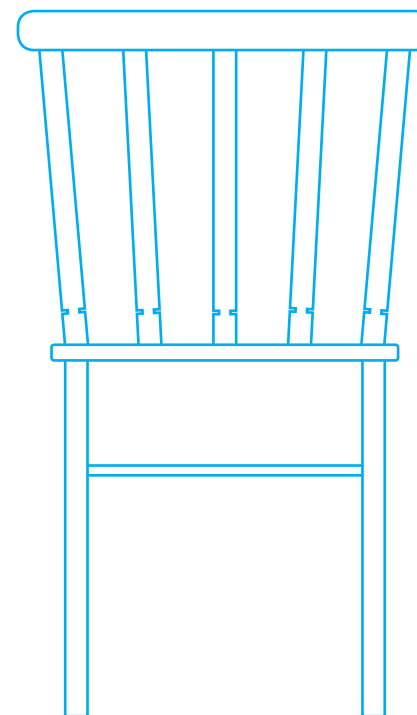

Alternativ  
#1.2.046+049

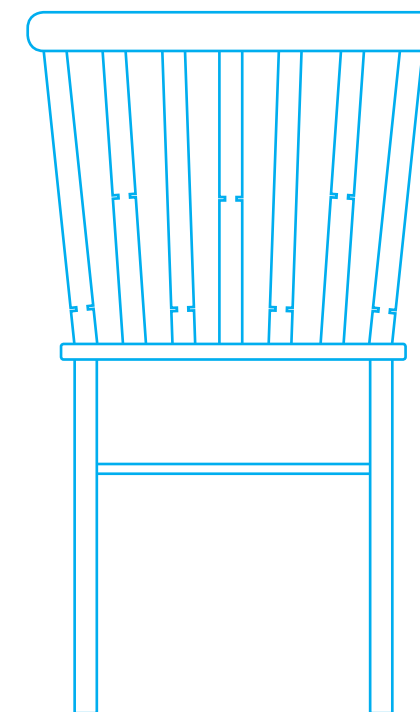

Produkten finns i flera utföranden, s. 6 - 7. (The product is available in several designs, p. 6 - 7.)





# 047

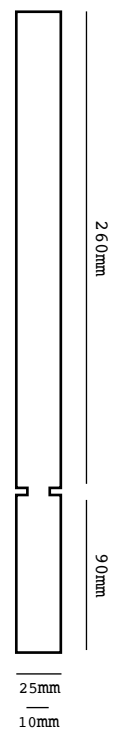

**PRODUKTFAKTA**

**Pinnar** (spindles): 1-pack / 2-pack / 5-pack

**Material** (material): **Björk** (birch)

**Färgval** (colour): s. (p.) 232 - 233

Standard  
#1.1.047

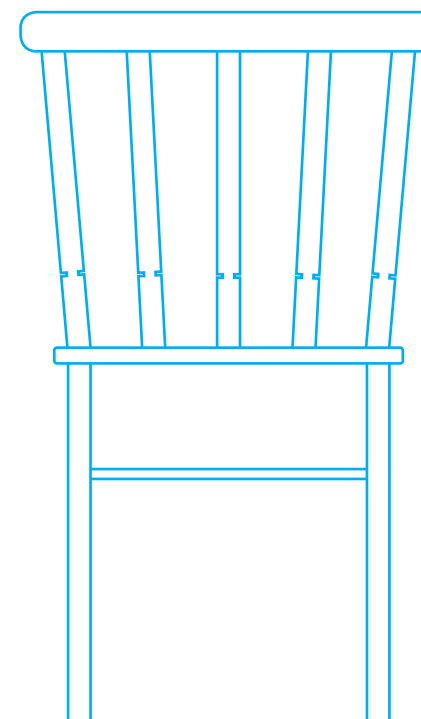

Alternativ  
#2.1.047

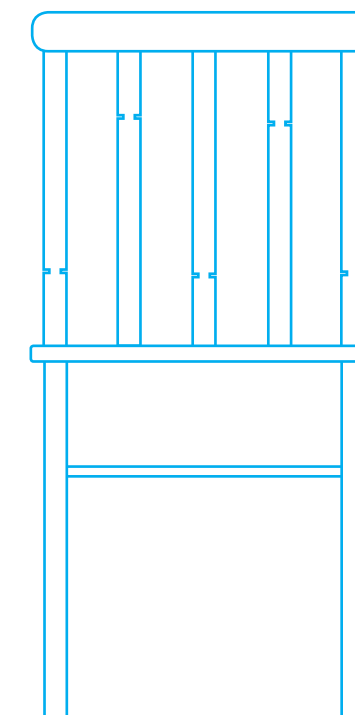

Produkten finns i flera utföranden, s. 6 - 7. (The product is available in several designs, p. 6 - 7.)



# 048

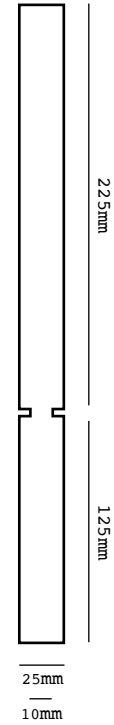

**PRODUKTFAKTA**

**Pinnar** (spindles): 1-pack / 2-pack / 5-pack

**Material** (material): **Björk** (birch)

**Färgval** (colour): s. (p.) 232 - 233

Standard  
#1.1.048

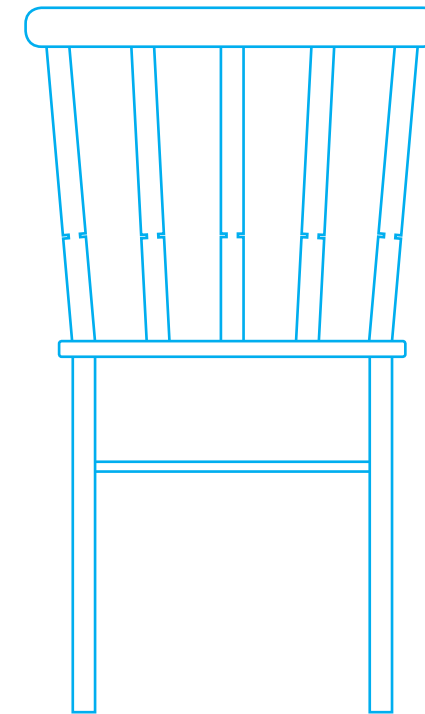

Alternativ  
#1.3.046+047+048

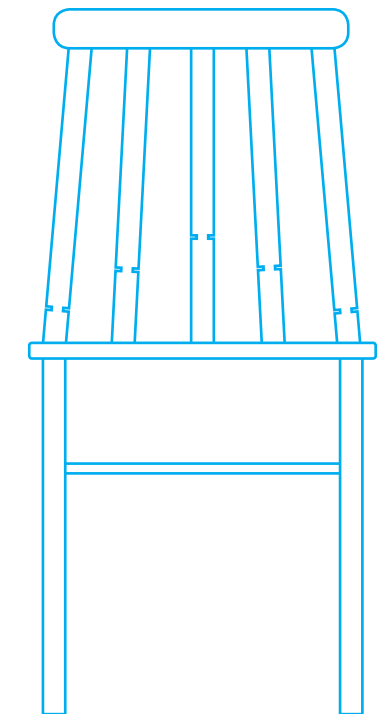

Produkten finns i flera utföranden, s. 6 - 7. (The product is available in several designs, p. 6 - 7.)



# 049

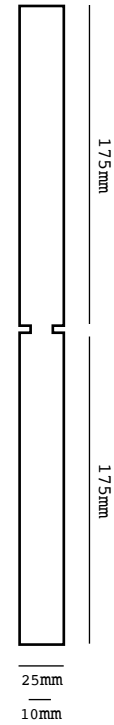

**PRODUKTFAKTA**

**Pinnar** (spindles): 1-pack / 2-pack / 5-pack

**Material** (material): **Björk** (birch)

**Färgval** (colour): s. (p.) 232 - 233

Standard  
#1.1.049

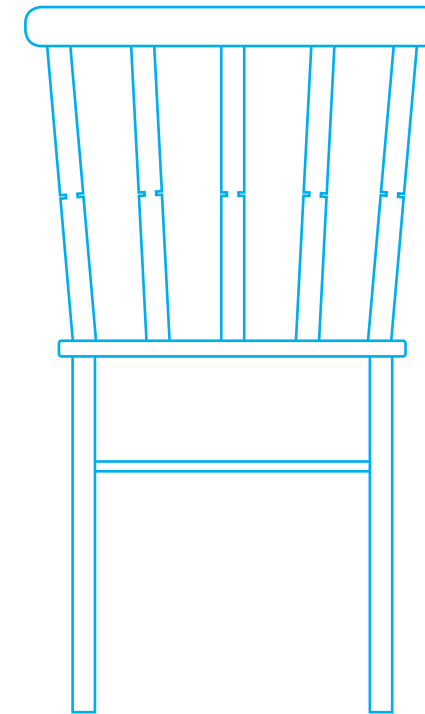

Alternativ  
#2.2.046+047+048+049

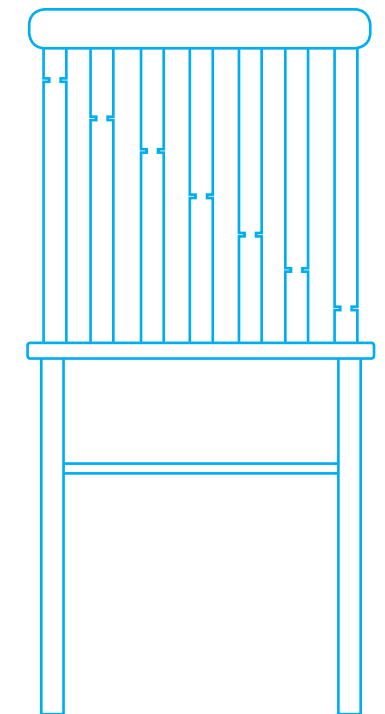

Produkten finns i flera utföranden, s. 6 - 7. (The product is available in several designs, p. 6 - 7.)



# 050

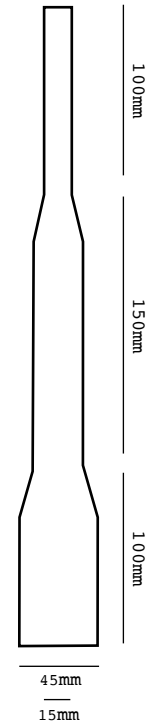

**PRODUKTFAKTA**

**Pinnar** (spindles): 1-pack / 2-pack / 5-pack

**Material** (material): **Björk** (birch)

**Färgval** (colour): s. (p.) 232 - 233

Standard  
#1.1.050

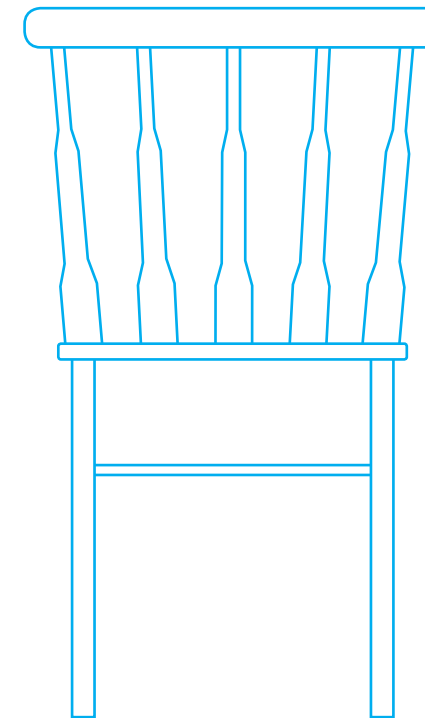

Alternativ  
#2.2.050+051+052+053

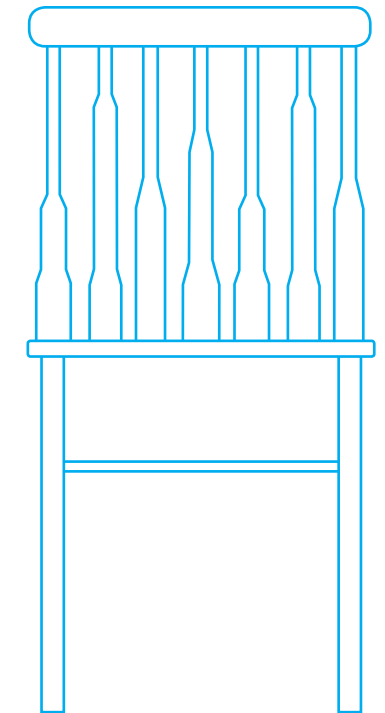

Produkten finns i flera utföranden, s. 6 - 7. (The product is available in several designs, p. 6 - 7.)



# 051

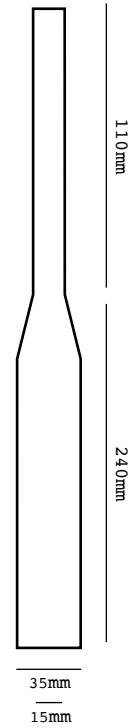

**PRODUKTFAKTA**

**Pinnar** (spindles): 1-pack / 2-pack / 5-pack

**Material** (material): **Björk** (birch)

**Färgval** (colour): s. (p.) 232 - 233

Standard  
#1.1.051

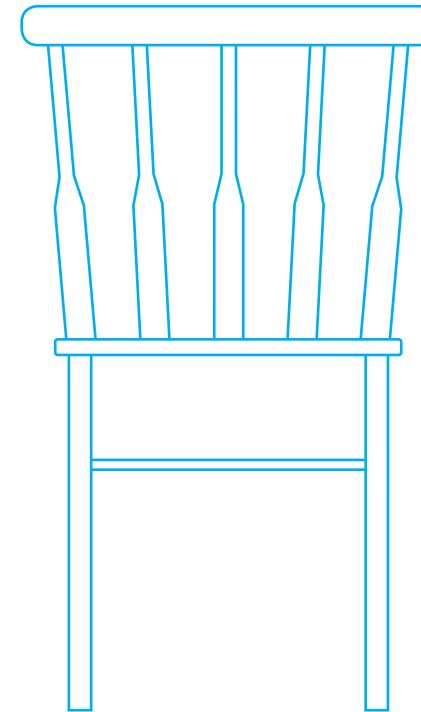

Alternativ  
#1.3.051

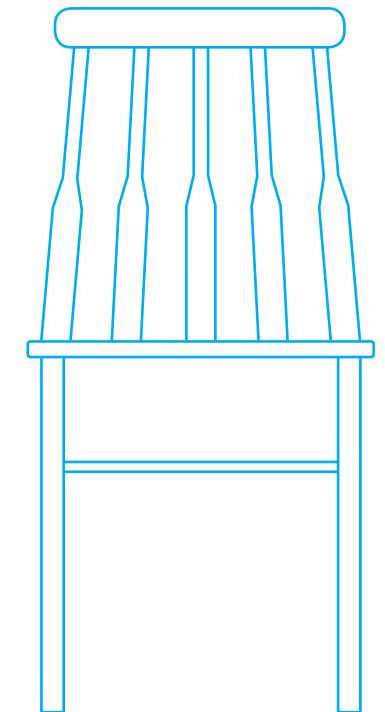

Produkten finns i flera utföranden, s. 6 - 7. (The product is available in several designs, p. 6 - 7.)

# 052

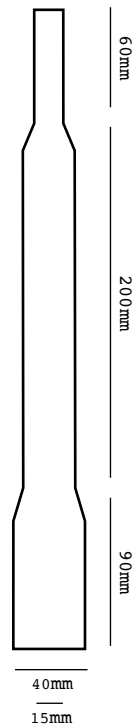

## PRODUKTFAKTA

**Pinnar** (spindles): 1-pack / 2-pack / 5-pack

**Material** (material): Björk (birch)

**Färgval** (colour): s. (p.) 232 - 233

Standard  
#1.1.052

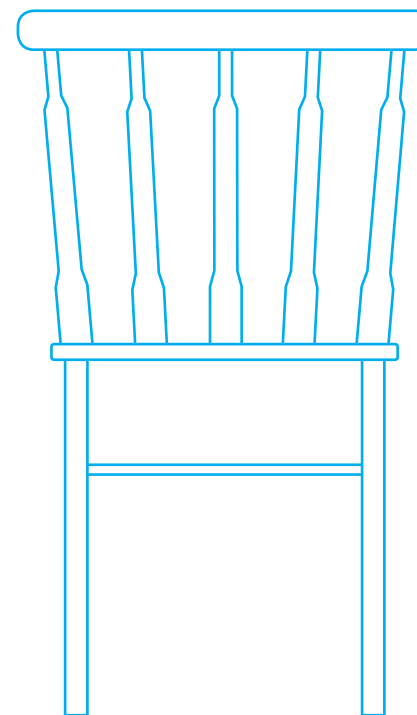

Alternativ  
#1.3.051+052

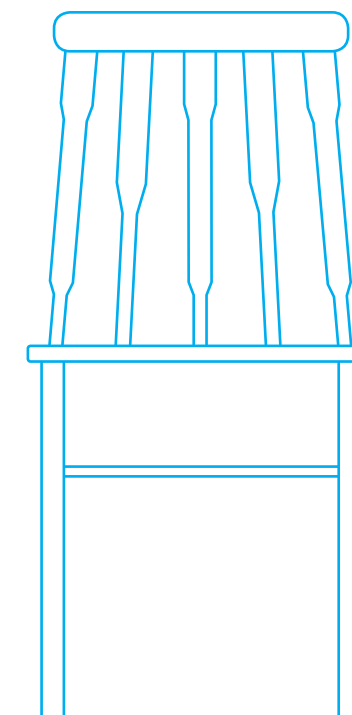

Produkten finns i flera utföranden, s. 6 - 7. (The product is available in several designs, p. 6 - 7.)

# 053

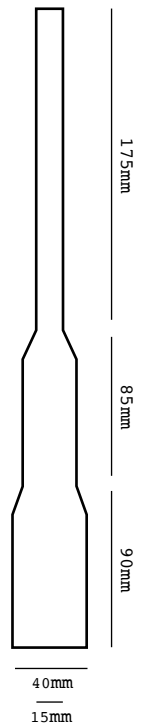

## PRODUKTFAKTA

**Pinnar** (spindles): 1-pack / 2-pack / 5-pack

**Material** (material): **Björk** (birch)

**Färgval** (colour): s. (p.) 232 - 233

Standard  
#1.1.053

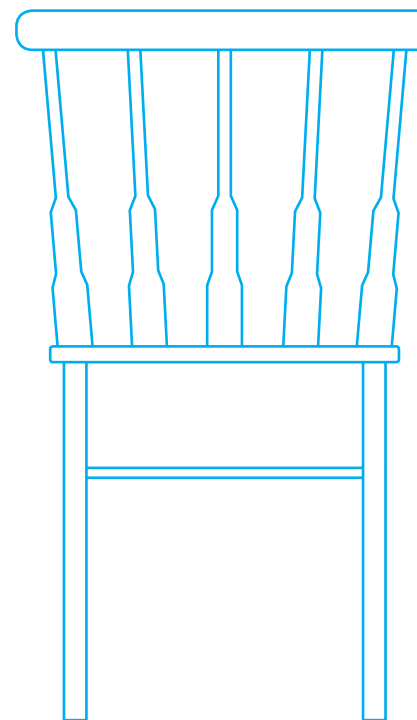

Alternativ  
#2.1.050+051+052+053

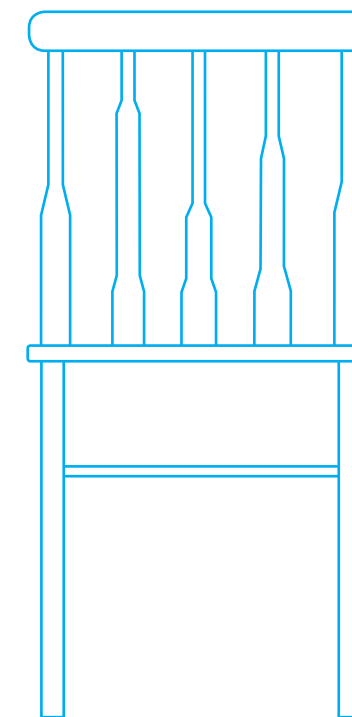

Produkten finns i flera utföranden, s. 6 - 7. (The product is available in several designs, p. 6 - 7.)

***Pelarkollektionen***  
*(The Pillar Collection)*





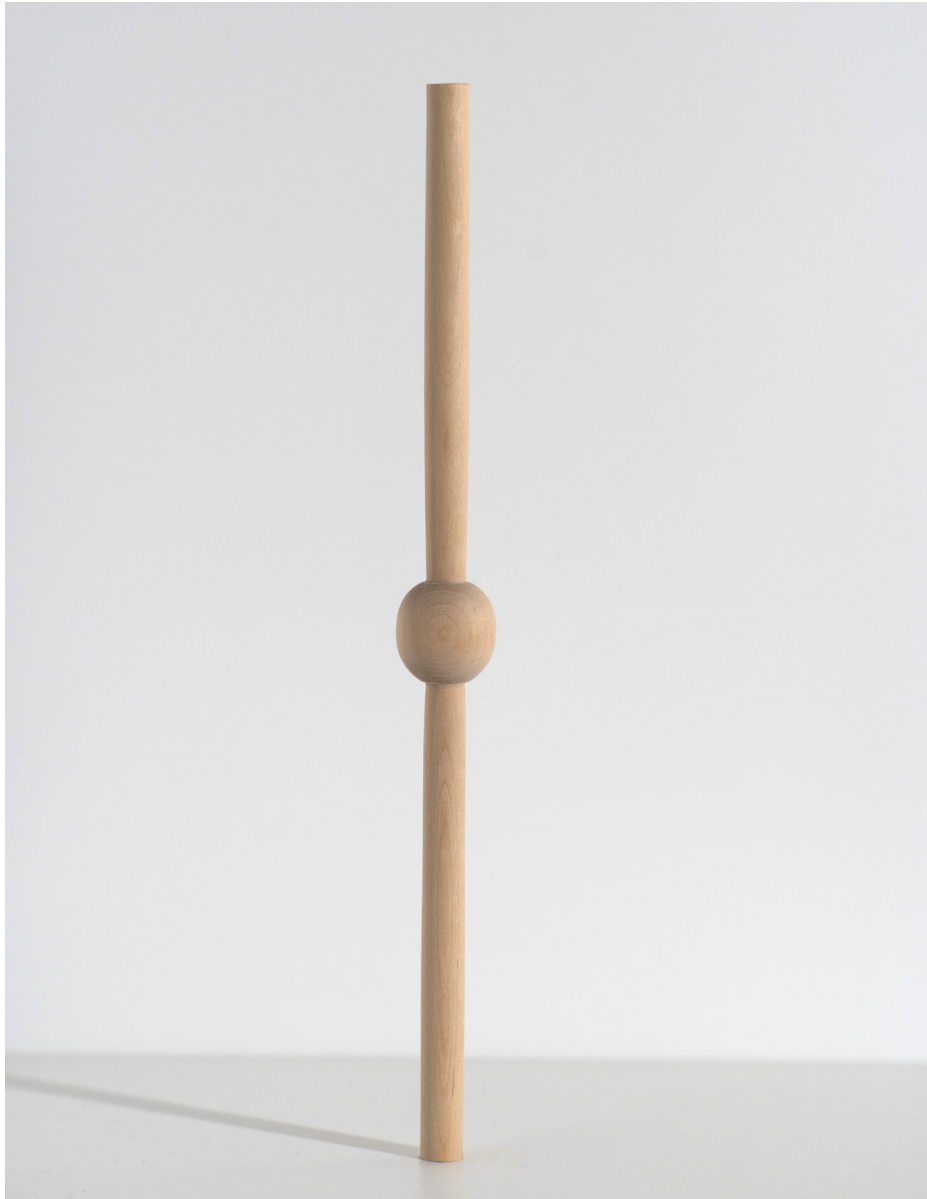

# 054

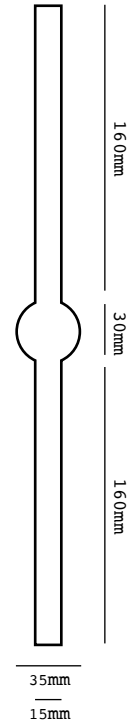

## PRODUKTFAKTA

**Pinnar** (spindles): 1-pack / 2-pack / 5-pack

**Material** (material): **Björk** (birch)

**Färgval** (colour): s. (p.) 232 - 233

Standard  
#1.1.054

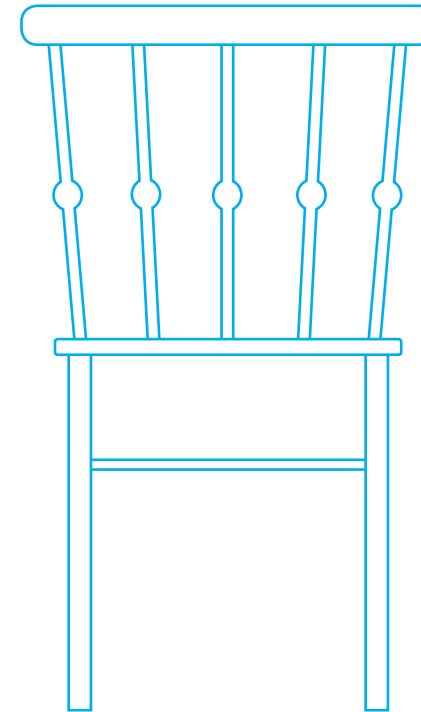

Alternativ  
#1.1.054+081

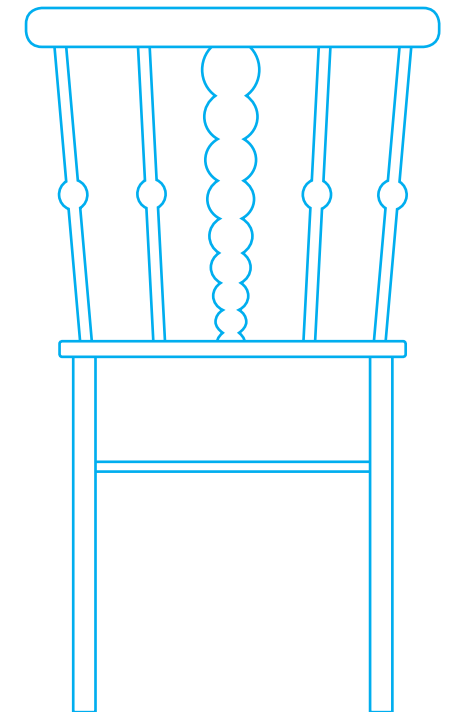

Produkten finns i flera utföranden, s. 6 - 7. (The product is available in several designs, p. 6 - 7.)



# 055

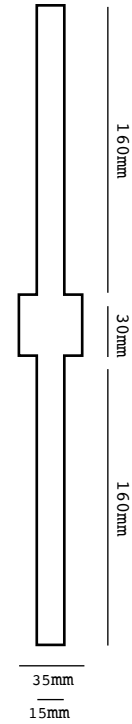

## PRODUKTFAKTA

**Pinnar** (spindles): 1-pack / 2-pack / 5-pack

**Material** (material): **Björk** (birch)

**Färgval** (colour): s. (p.) 232 - 233

Standard  
#1.1.055

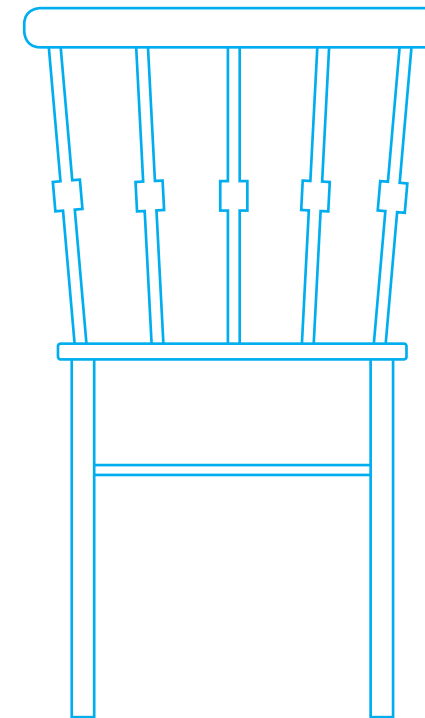

Alternativ  
#2.1.055+057

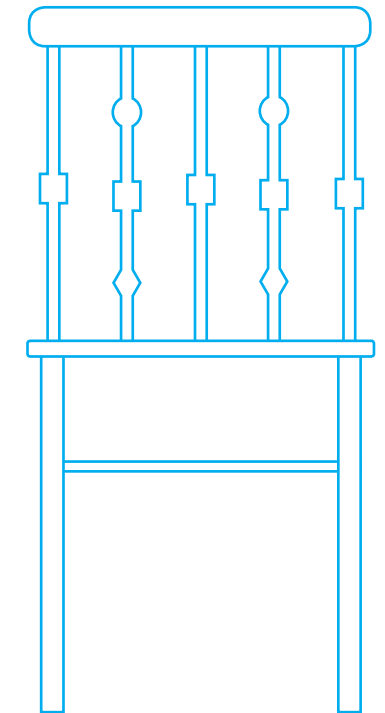

Produkten finns i flera utföranden, s. 6 - 7. (The product is available in several designs, p. 6 - 7.)



# 056

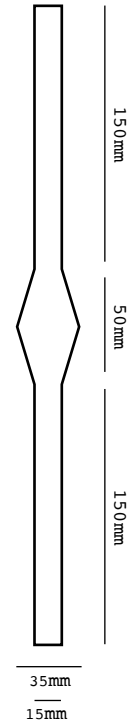

## PRODUKTFAKTA

**Pinnar** (spindles): 1-pack / 2-pack / 5-pack

**Material** (material): **Björk** (birch)

**Färgval** (colour): s. (p.) 232 - 233

Standard  
#1.1.056

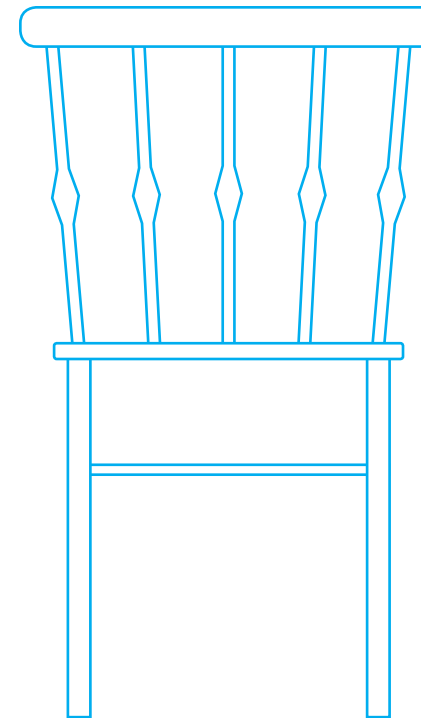

Alternativ  
#1.2.054+055+056

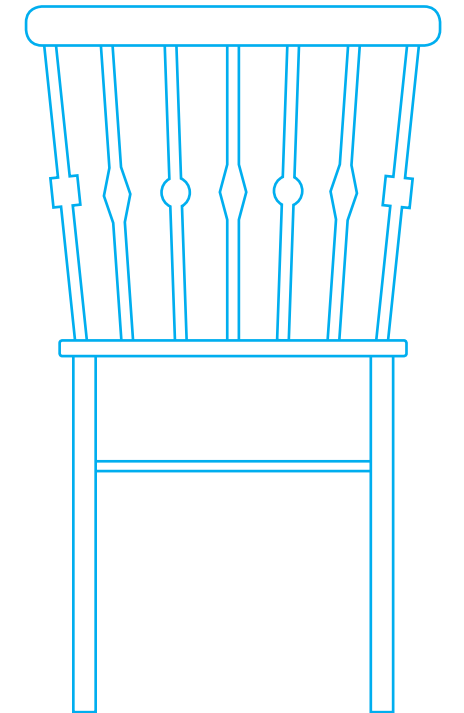

Produkten finns i flera utföranden, s. 6 - 7. (The product is available in several designs, p. 6 - 7.)



# 057

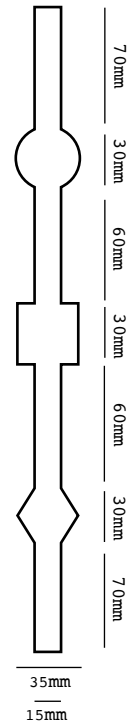

**PRODUKTFAKTA**

**Pinnar** (spindles): 1-pack / 2-pack / 5-pack

**Material** (material): **Björk** (birch)

**Färgval** (colour): s. (p.) 232 - 233

Standard  
#1.1.057

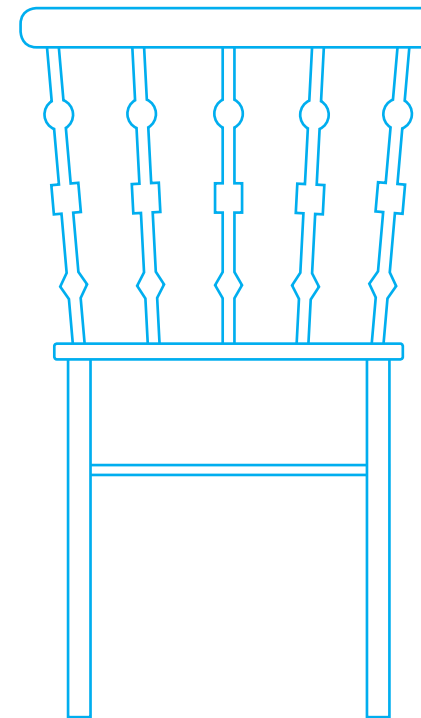

Alternativ  
#1.1.054+055+056+057

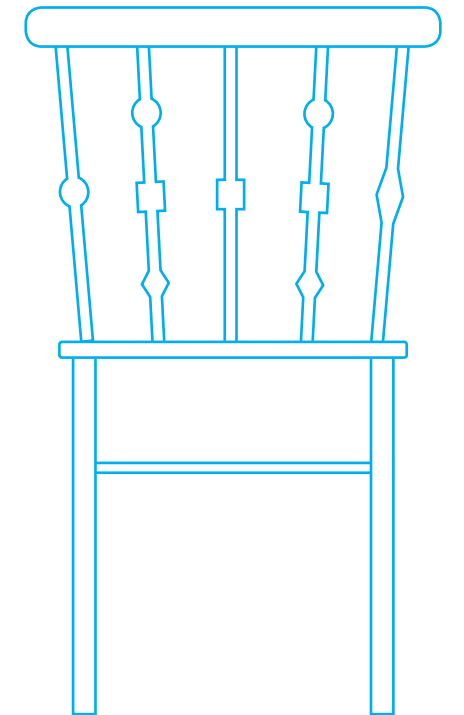

Produkten finns i flera utföranden, s. 6 - 7. (The product is available in several designs, p. 6 - 7.)



# 058

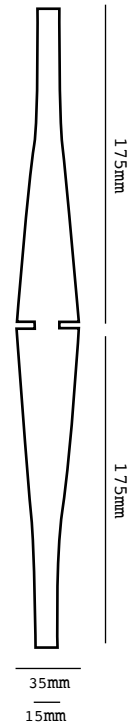

**PRODUKTFAKTA**

**Pinnar** (spindles): 1-pack / 2-pack / 5-pack

**Material** (material): Björk (birch)

**Färgval** (colour): s. (p.) 232 - 233

Standard  
#1.1.058

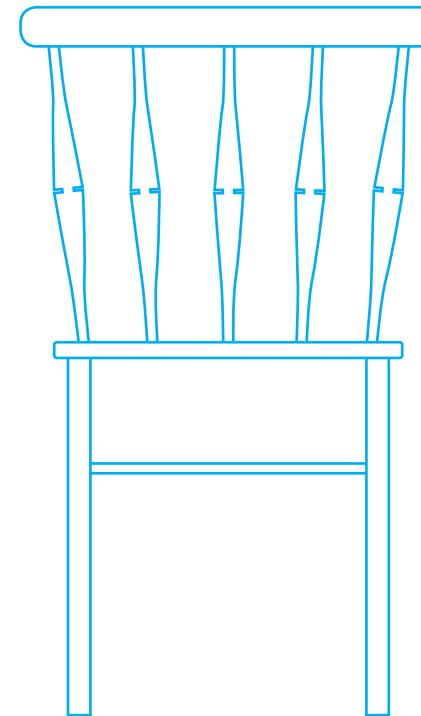

Alternativ  
#2.1.058+059

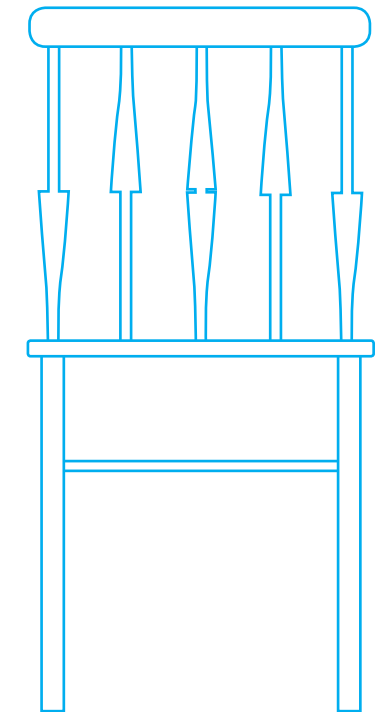

Produkten finns i flera utföranden, s. 6 - 7. (The product is available in several designs, p. 6 - 7.)



# 059

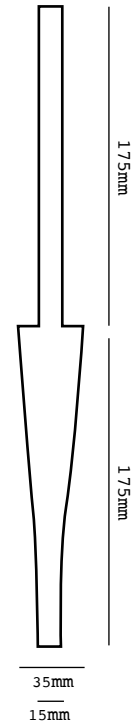

**PRODUKTFAKTA**

**Pinnar** (spindles): 1-pack / 2-pack / 5-pack

**Material** (material): **Björk** (birch)

**Färgval** (colour): s. (p.) 232 - 233

Standard  
#1.1.059

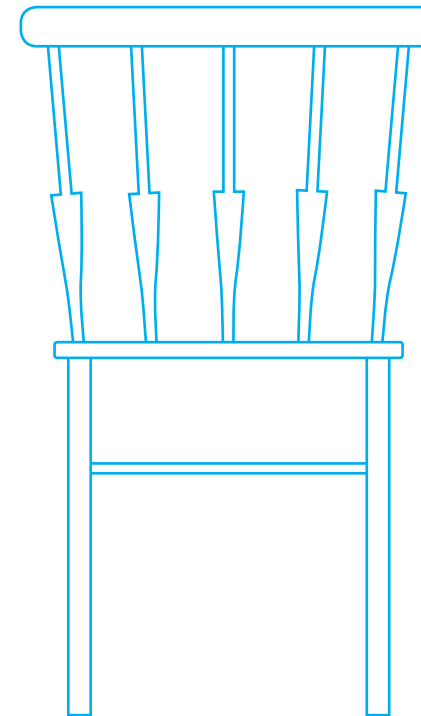

Alternativ  
#1.2.059

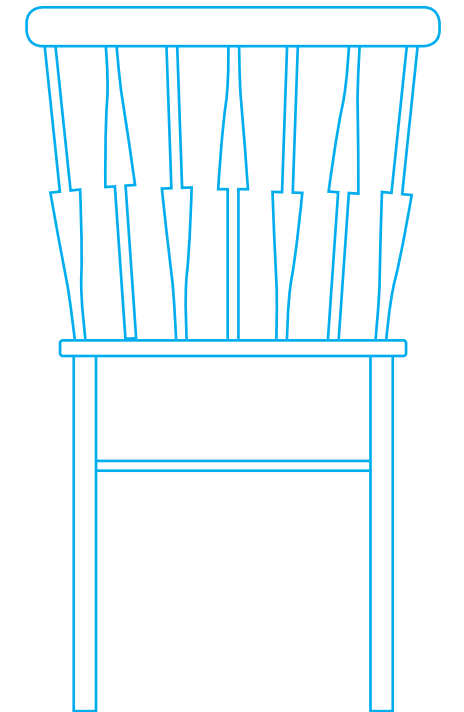

Produkten finns i flera utföranden, s. 6 - 7. (The product is available in several designs, p. 6 - 7.)



# 060

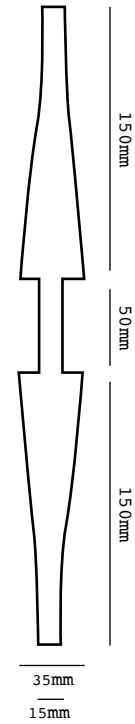

**PRODUKTFAKTA**

**Pinnar** (spindles): 1-pack / 2-pack / 5-pack

**Material** (material): **Björk** (birch)

**Färgval** (colour): s. (p.) 232 - 233

Standard  
#1.1.060

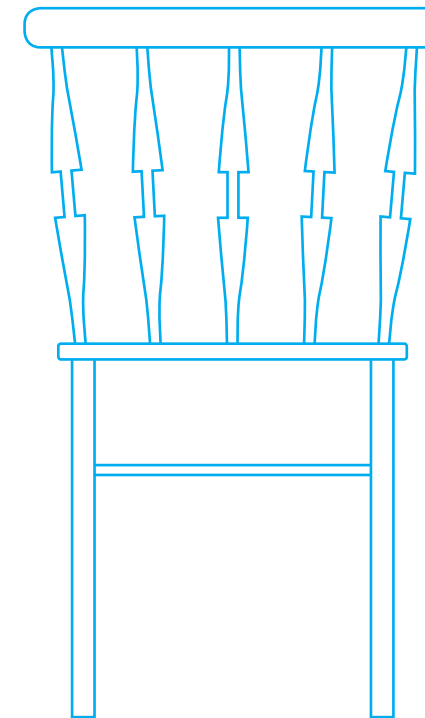

Alternativ  
#1.2.055+060

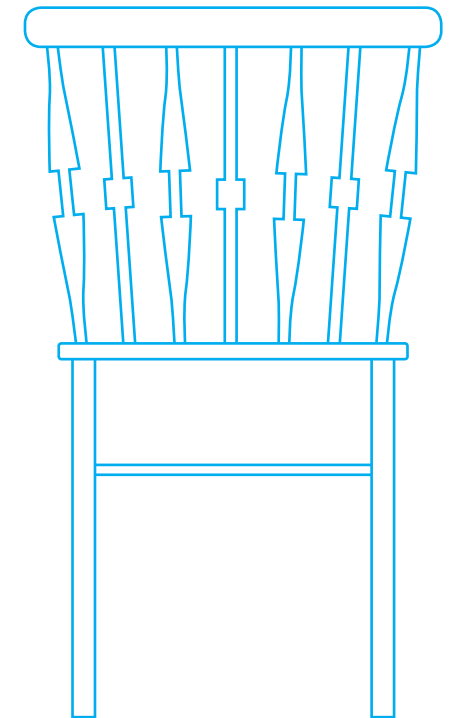

Produkten finns i flera utföranden, s. 6 - 7. (The product is available in several designs, p. 6 - 7.)



# 061

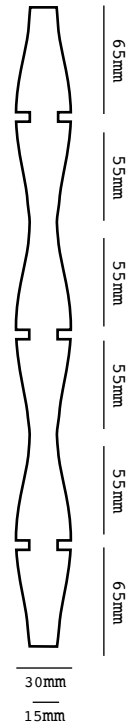

## PRODUKTFAKTA

**Pinnar** (spindles): 1-pack / 2-pack / 5-pack

**Material** (material): **Björk** (birch)

**Färgval** (colour): s. (p.) 232 - 233

Standard  
#1.1.061

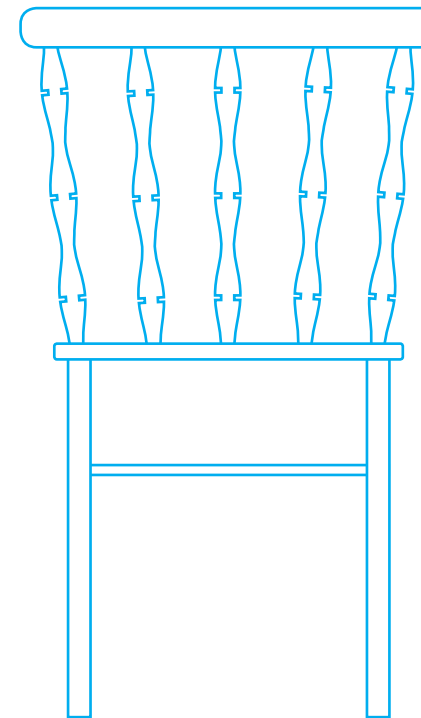

Alternativ  
#1.1.002+061

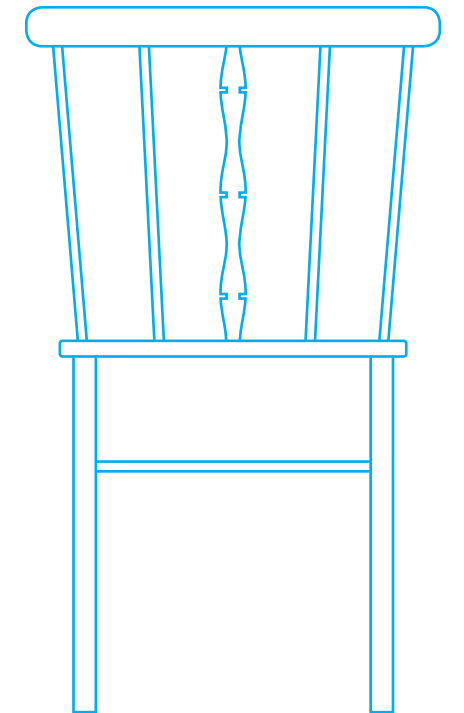

Produkten finns i flera utföranden, s. 6 - 7. (The product is available in several designs, p. 6 - 7.)





# 062

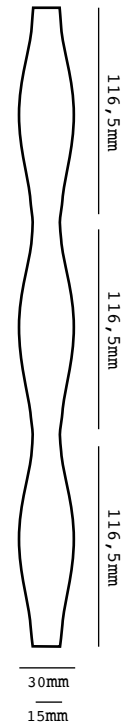

**PRODUKTFAKTA**

**Pinnar** (spindles): 1-pack / 2-pack / 5-pack

**Material** (material): **Björk** (birch)

**Färgval** (colour): s. (p.) 232 - 233

Standard  
#1.1.062

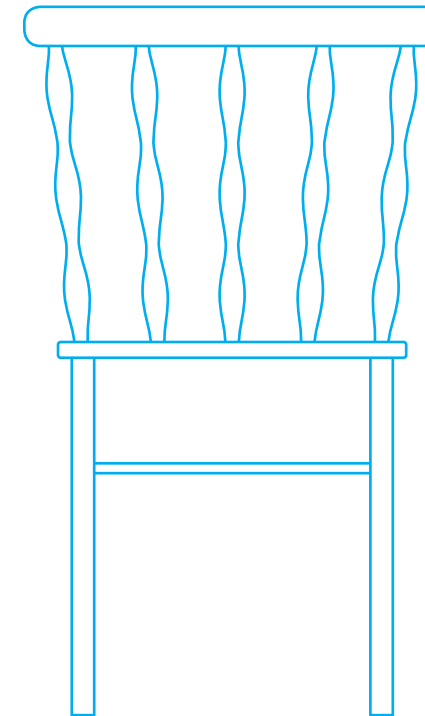

Alternativ  
#1.1.061+062

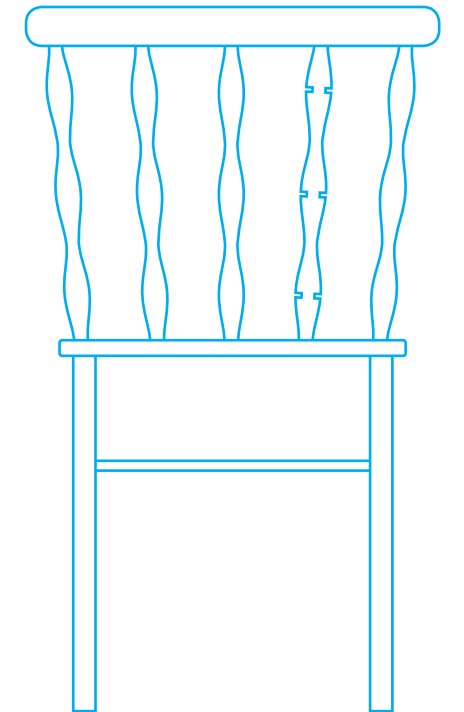

Produkten finns i flera utföranden, s. 6 - 7. (The product is available in several designs, p. 6 - 7.)



# 063

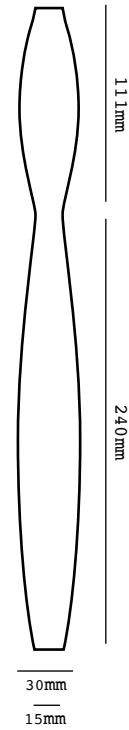

**PRODUKTFAKTA**

**Pinnar** (spindles): 1-pack / 2-pack / 5-pack

**Material** (material): **Björk** (birch)

**Färgval** (colour): s. (p.) 232 - 233

Standard  
#1.1.063

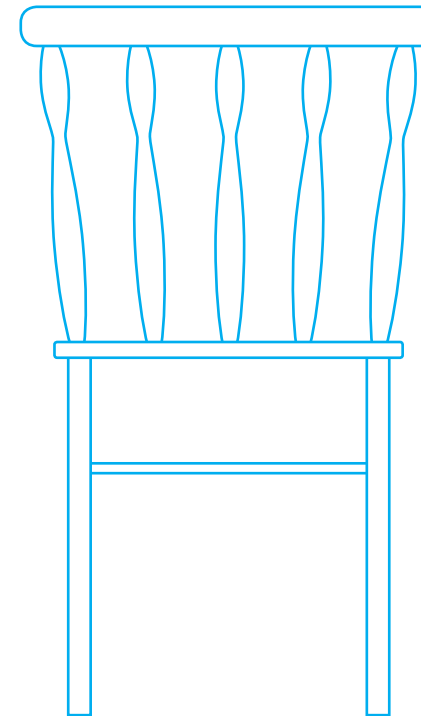

Alternativ  
#1.3.063

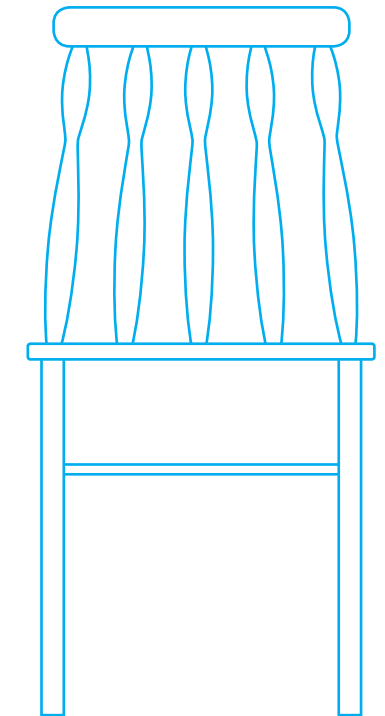

Produkten finns i flera utföranden, s. 6 - 7. (The product is available in several designs, p. 6 - 7.)



# 064

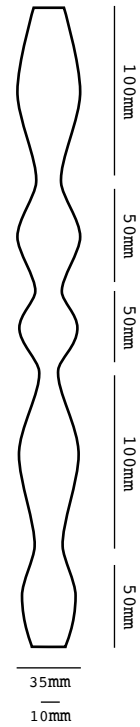

**PRODUKTFAKTA**

**Pinnar** (spindles): 1-pack / 2-pack / 5-pack

**Material** (material): Björk (birch)

**Färgval** (colour): s. (p.) 232 - 233

Standard  
#1.1.064

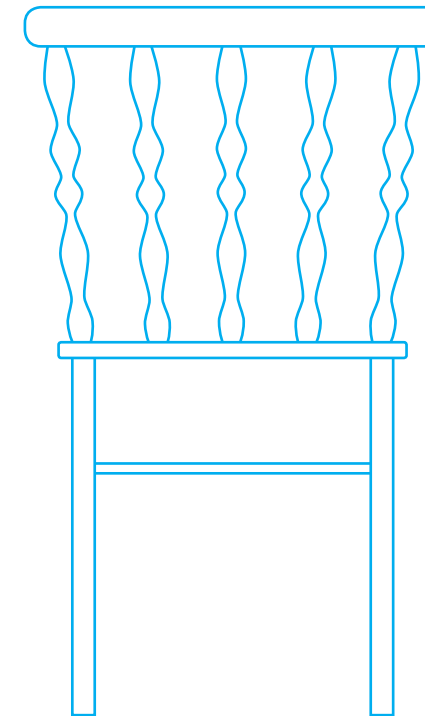

Alternativ  
#2.1.004+064

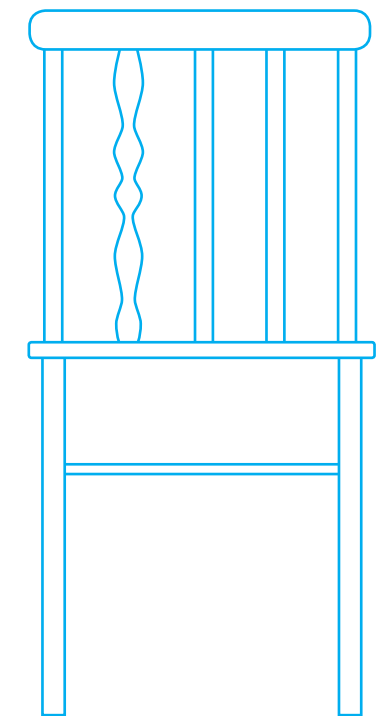

Produkten finns i flera utföranden, s. 6 - 7. (The product is available in several designs, p. 6 - 7.)



# 065

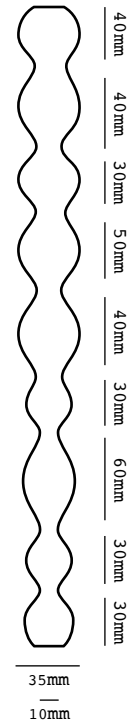

## PRODUKTFAKTA

**Pinnar** (spindles): 1-pack / 2-pack / 5-pack

**Material** (material): **Björk** (birch)

**Färgval** (colour): s. (p.) 232 - 233

Standard  
#1.1.065

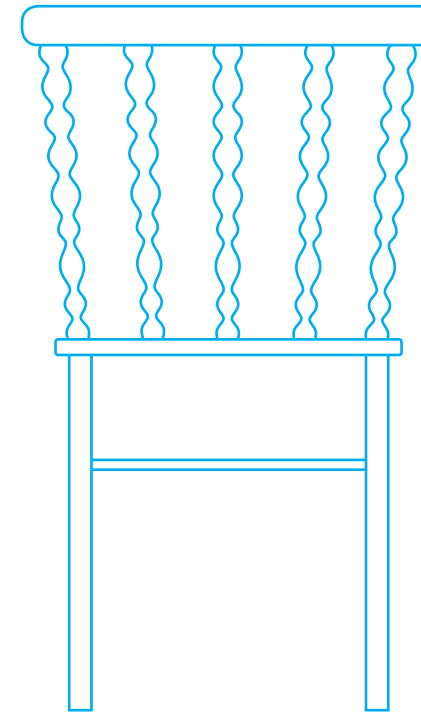

Alternativ  
#2.1.062+063+064+065

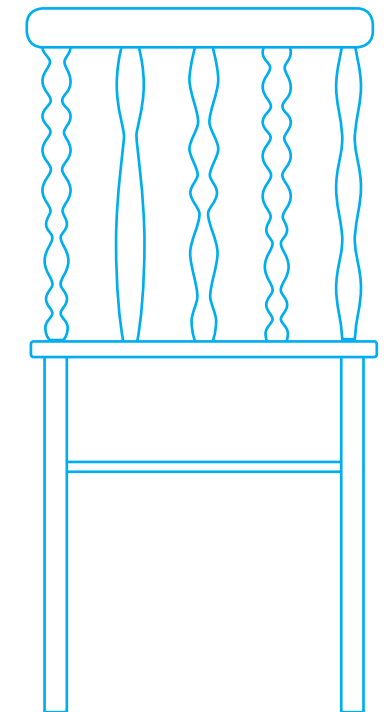

Produkten finns i flera utföranden, s. 6 - 7. (The product is available in several designs, p. 6 - 7.)



# 066

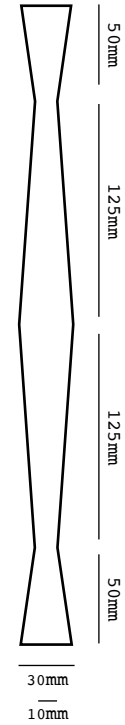

**PRODUKTFAKTA**

**Pinnar** (spindles): 1-pack / 2-pack / 5-pack

**Material** (material): **Björk** (birch)

**Färgval** (colour): s. (p.) 232 - 233

Standard  
#1.1.066

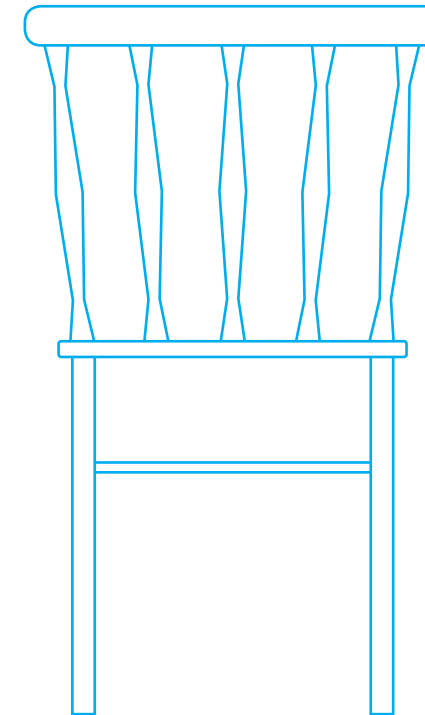

Alternativ  
#2.2.001+066

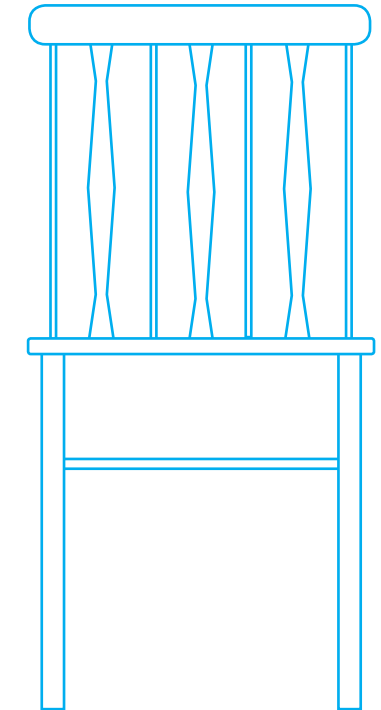

Produkten finns i flera utföranden, s. 6 - 7. (The product is available in several designs, p. 6 - 7.)



# 067

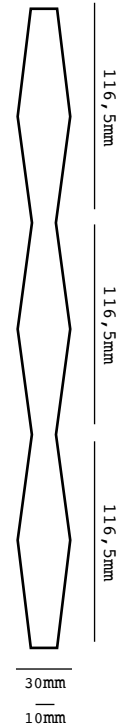

**PRODUKTFAKTA**

**Pinnar** (spindles): 1-pack / 2-pack / 5-pack

**Material** (material): **Björk** (birch)

**Färgval** (colour): s. (p.) 232 - 233

Standard  
#1.1.067

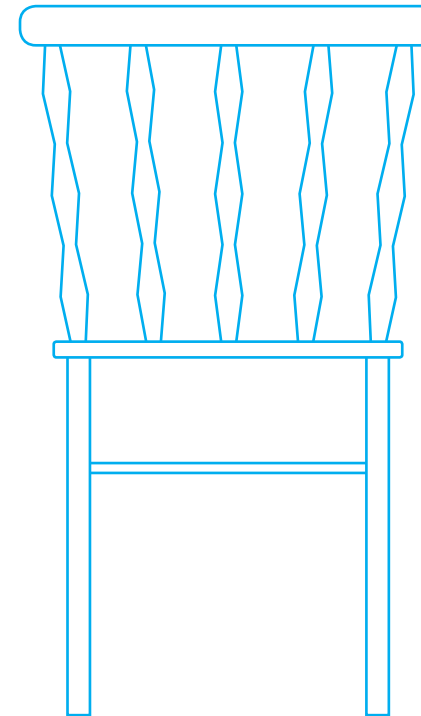

Alternativ  
#2.1.066+067

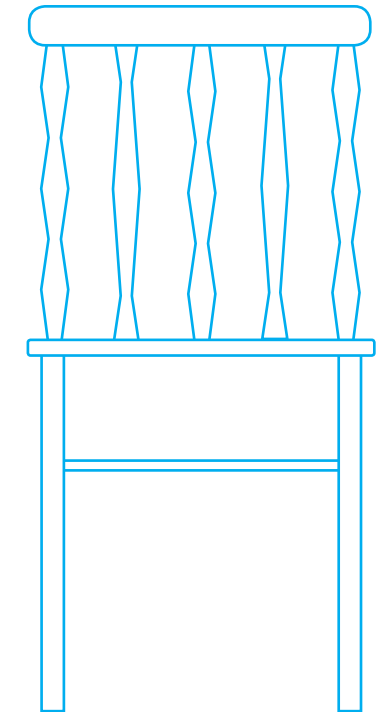

Produkten finns i flera utföranden, s. 6 - 7. (The product is available in several designs, p. 6 - 7.)



# 068

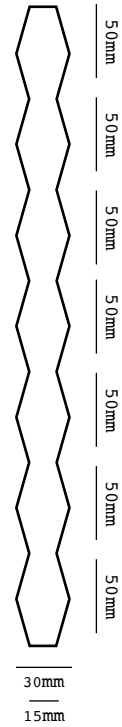

**PRODUKTFAKTA**

**Pinnar** (spindles): 1-pack / 2-pack / 5-pack

**Material** (material): **Björk** (birch)

**Färgval** (colour): s. (p.) 232 - 233

Standard  
#1.1.068

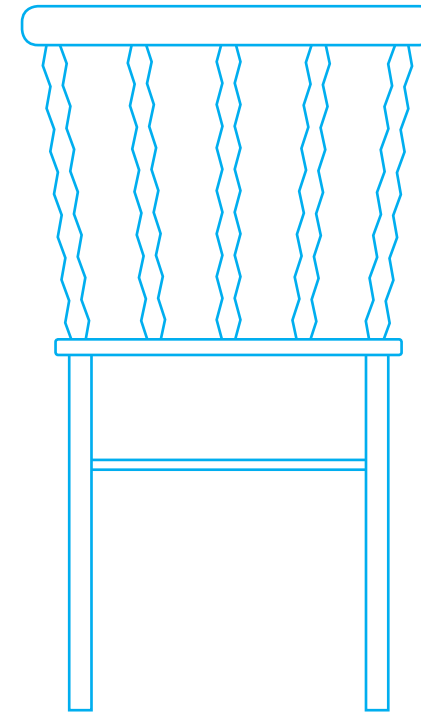

Alternativ  
#1.3.040+068

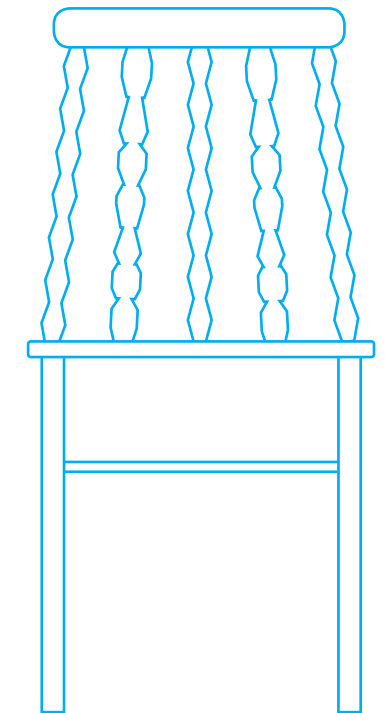

Produkten finns i flera utföranden, s. 6 - 7. (The product is available in several designs, p. 6 - 7.)



# 069

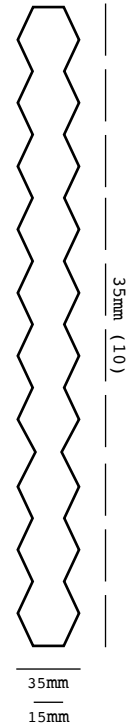

**PRODUKTFAKTA**

**Pinnar** (spindles): 1-pack / 2-pack / 5-pack

**Material** (material): **Björk** (birch)

**Färgval** (colour): s. (p.) 232 - 233

Standard  
#1.1.069

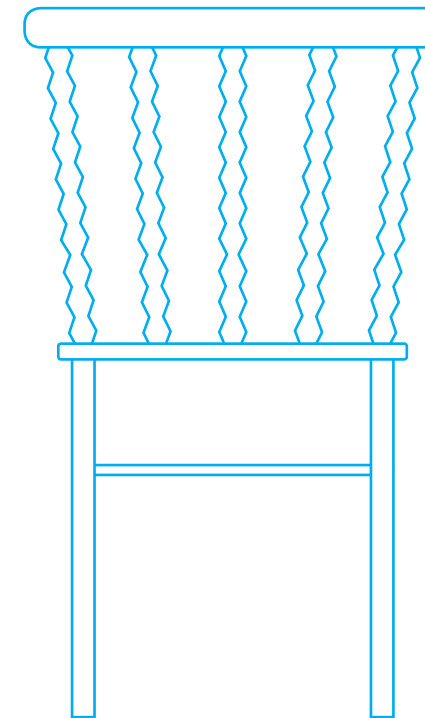

Alternativ  
#2.2.056+067+068+069

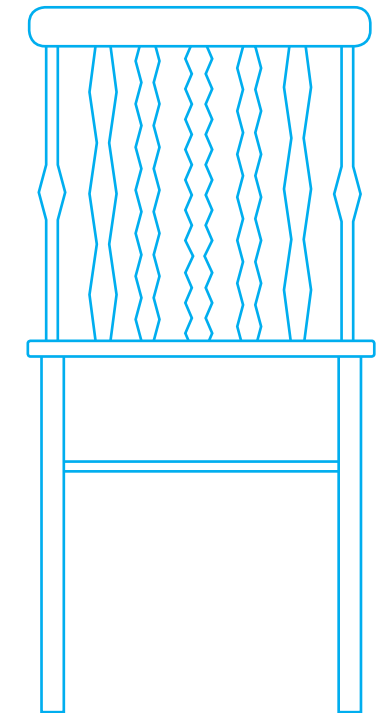

Produkten finns i flera utföranden, s. 6 - 7. (The product is available in several designs, p. 6 - 7.)





# 070

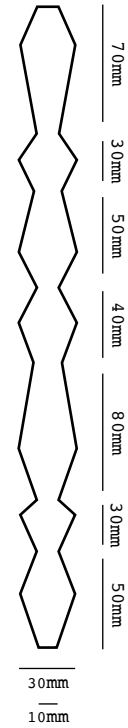

## PRODUKTFAKTA

**Pinnar** (spindles): 1-pack / 2-pack / 5-pack

**Material** (material): **Björk** (birch)

**Färgval** (colour): s. (p.) 232 - 233

Standard  
#1.1.070

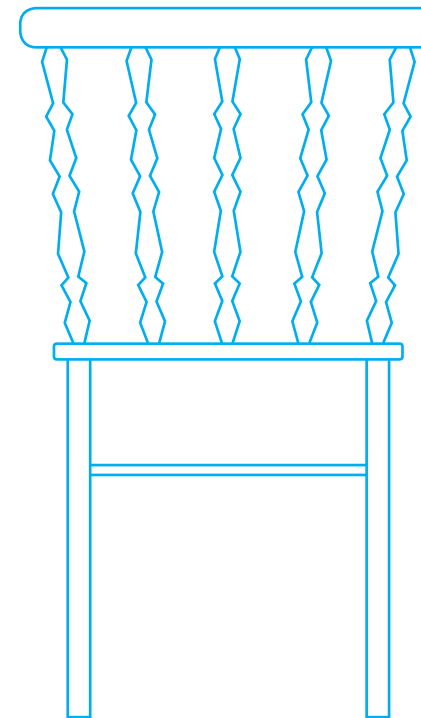

Alternativ  
#1.1.069+070

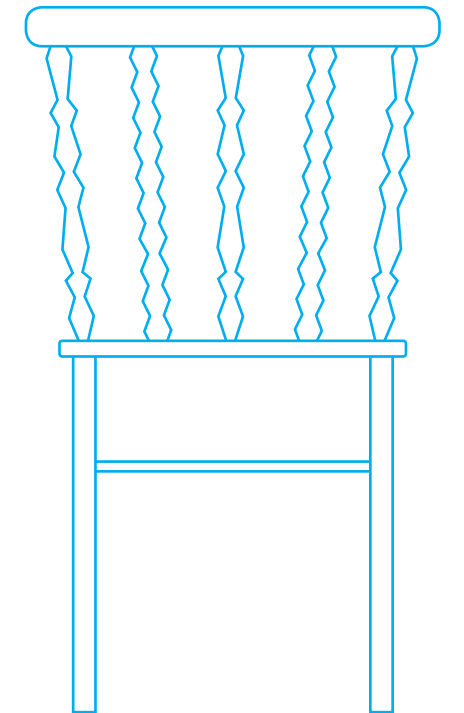

Produkten finns i flera utföranden, s. 6 - 7. (The product is available in several designs, p. 6 - 7.)











# 071

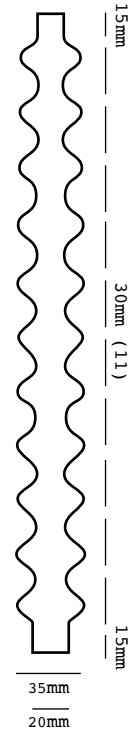

**PRODUKTFAKTA**

**Pinnar** (spindles): 1-pack / 2-pack / 5-pack

**Material** (material): **Björk** (birch)

**Färgval** (colour): s. (p.) 232 - 233

Standard  
#1.1.071

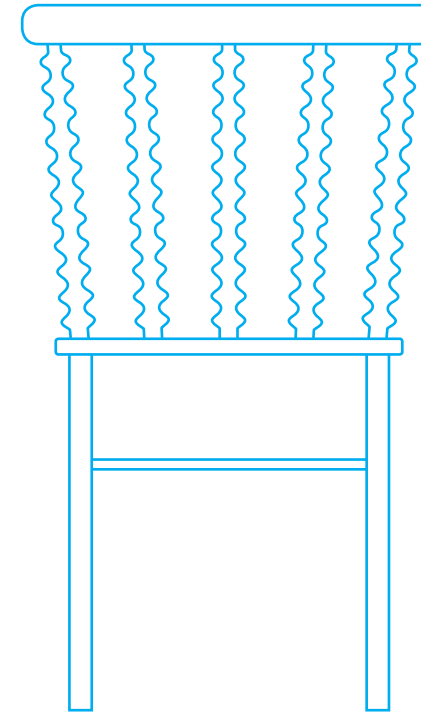

Alternativ  
#2.2.071

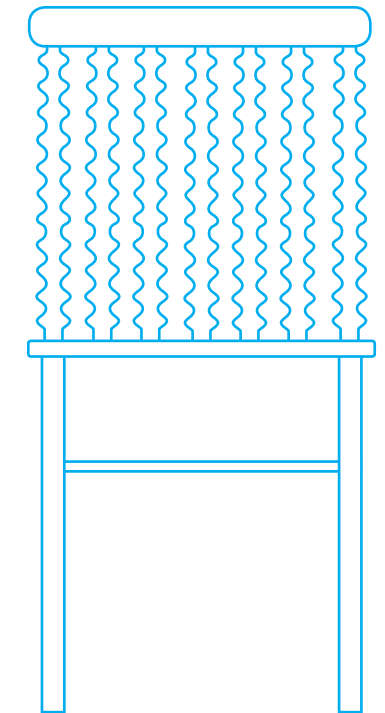

Produkten finns i flera utföranden, s. 6 - 7. (The product is available in several designs, p. 6 - 7.)

# 072

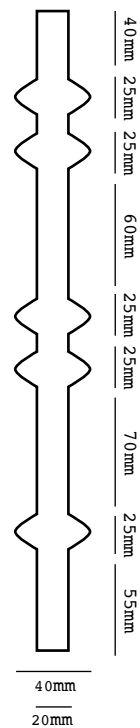

**PRODUKTFAKTA**

**Pinnar** (spindles): 1-pack / 2-pack / 5-pack

**Material** (material): **Björk** (birch)

**Färgval** (colour): s. (p.) 232 - 233

Standard  
#1.1.072

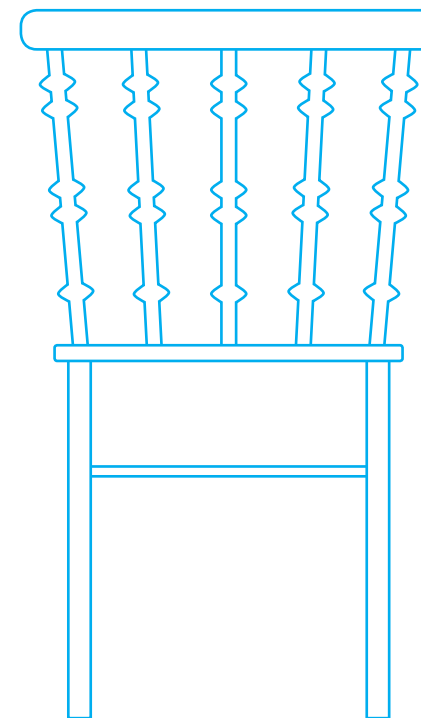

Alternativ  
#2.1.072+073

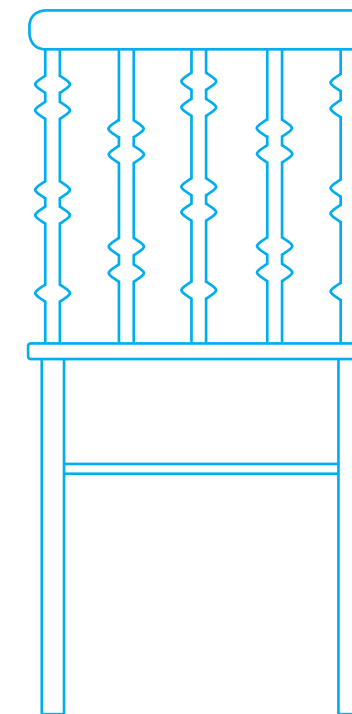

Produkten finns i flera utföranden, s. 6 - 7. (The product is available in several designs, p. 6 - 7.)



# 073

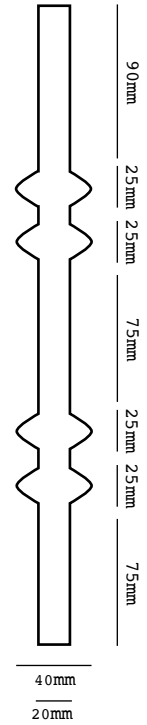

#### PRODUKTFAKTA

**Pinnar** (spindles): 1-pack / 2-pack / 5-pack

**Material** (material): **Björk** (birch)

**Färgval** (colour): s. (p.) 232 - 233

Standard  
#1.1.073

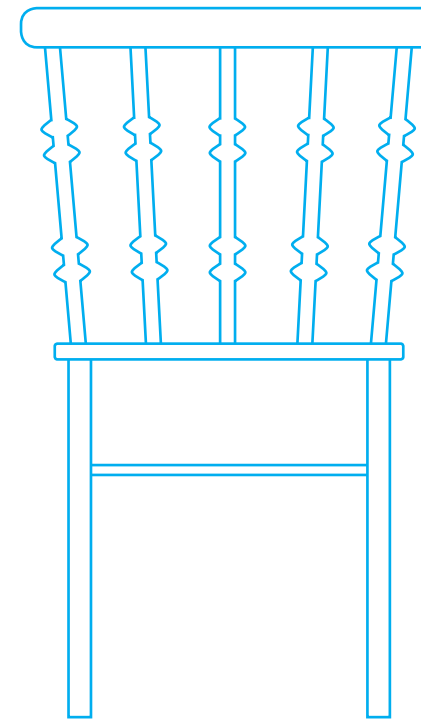

Alternativ  
#1.2.072+073+074

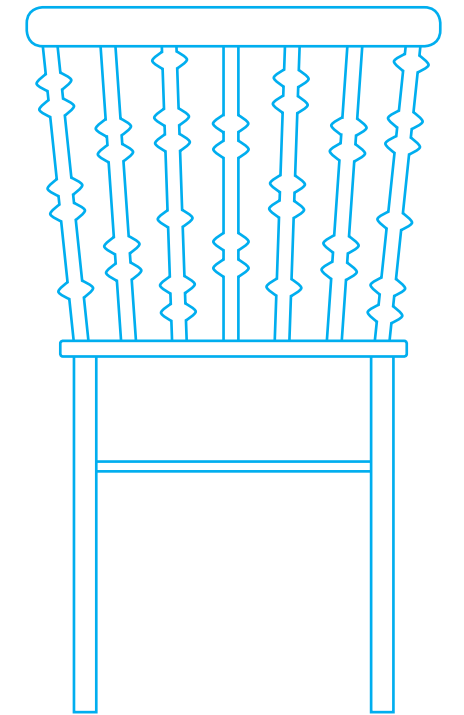

Produkten finns i flera utföranden, s. 6 - 7. (The product is available in several designs, p. 6 - 7.)





# 074

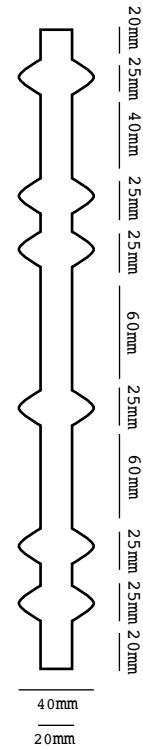

**PRODUKTFAKTA**

**Pinnar** (spindles): 1-pack / 2-pack / 5-pack

**Material** (material): **Björk** (birch)

**Färgval** (colour): s. (p.) 232 - 233

Standard  
#1.1.074

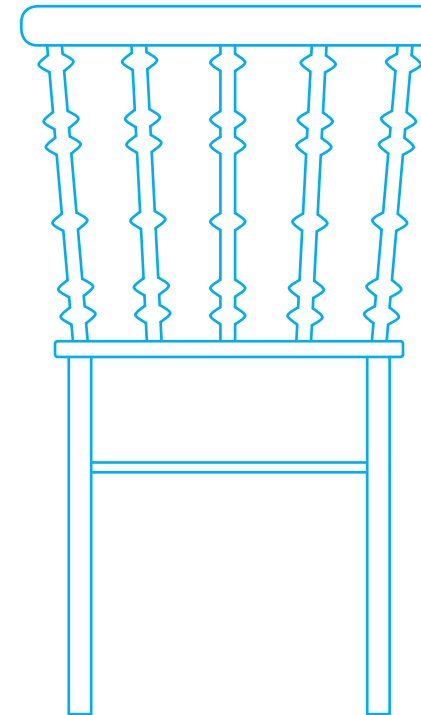

Alternativ  
#1.3.074

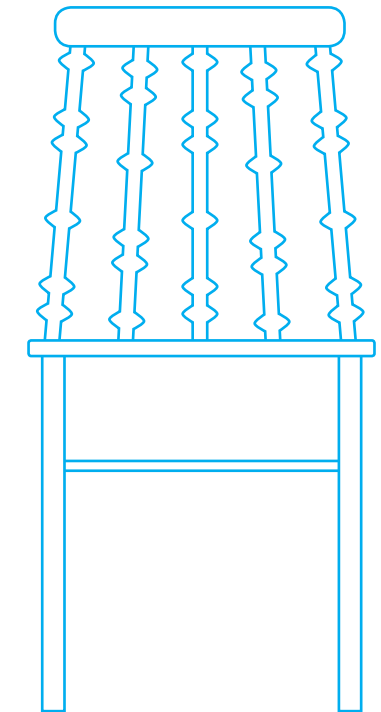

Produkten finns i flera utföranden, s. 6 - 7. (The product is available in several designs, p. 6 - 7.)



# 075

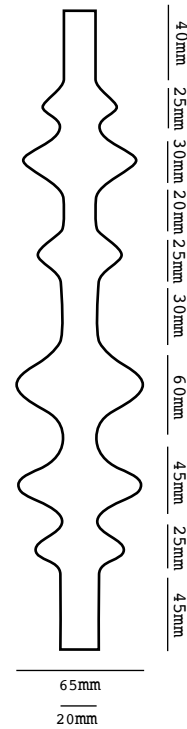

**PRODUKTFAKTA**

**Pinnar** (spindles): 1-pack / 2-pack / 5-pack

**Material** (material): Björk (birch)

**Färgval** (colour): s. (p.) 232 - 233

Standard  
#1.1.075

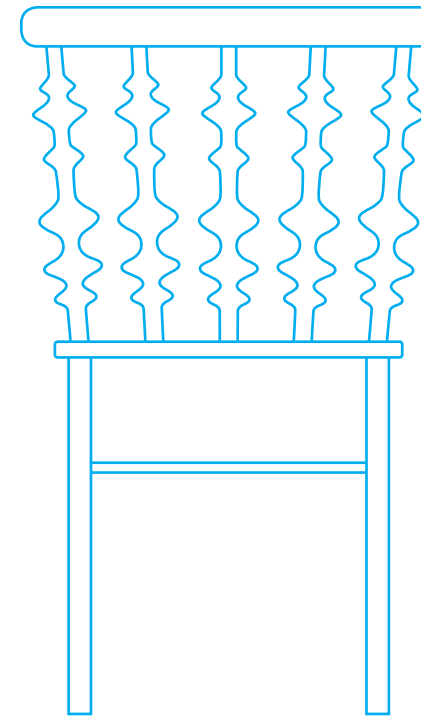

Alternativ  
#1.2.002+075

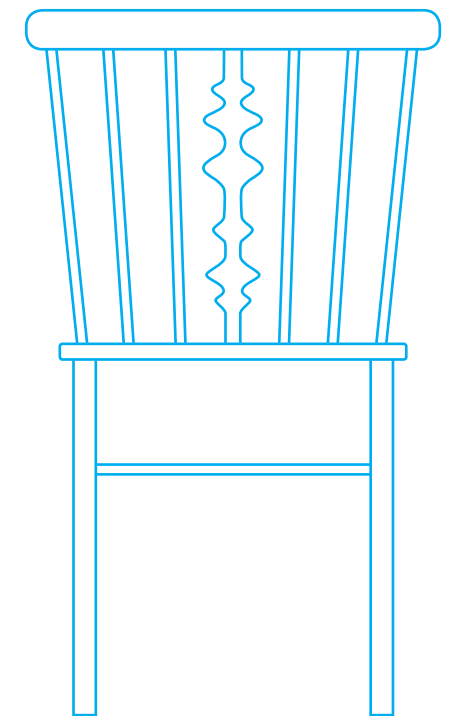

Produkten finns i flera utföranden, s. 6 - 7. (The product is available in several designs, p. 6 - 7.)

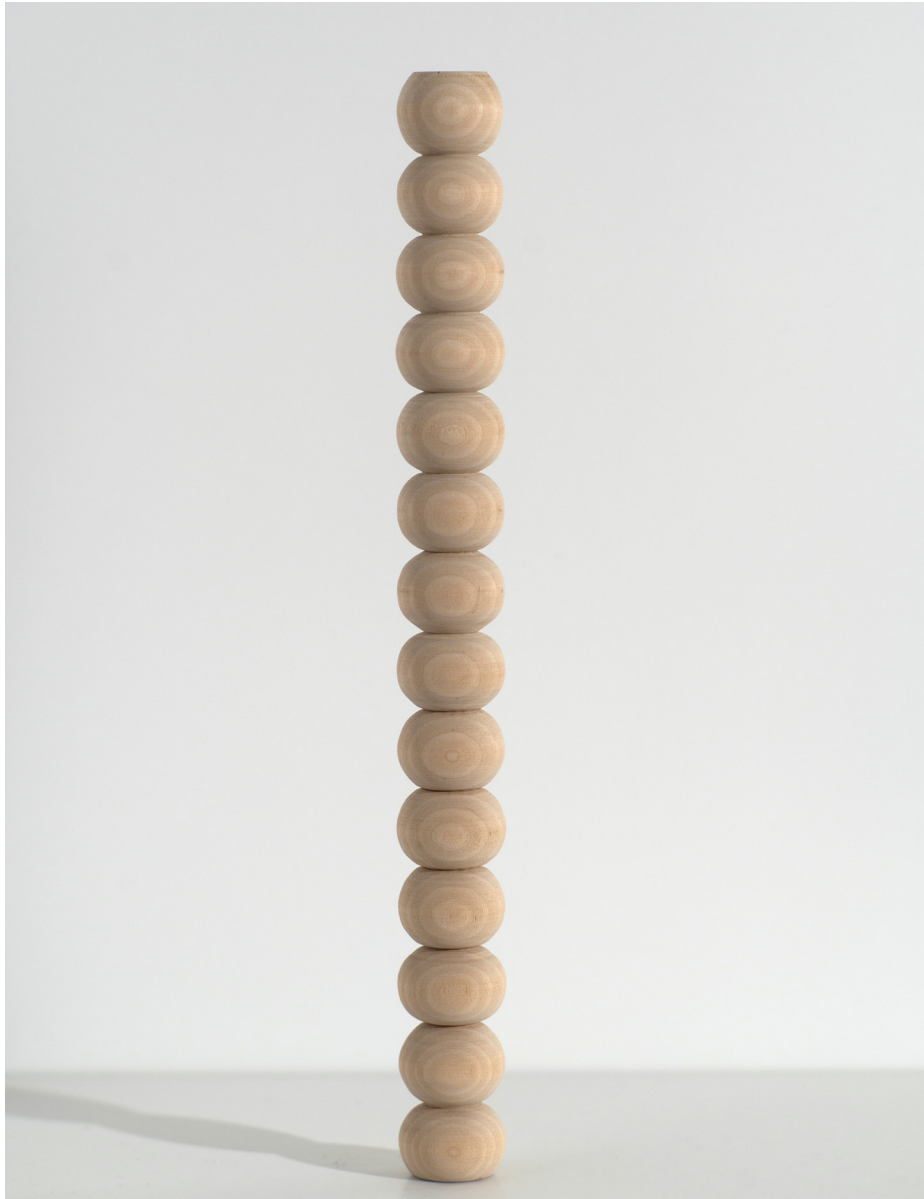

# 076

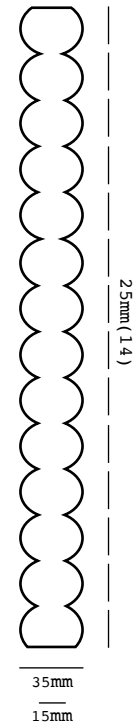

**PRODUKTFAKTA**

**Pinnar** (spindles): 1-pack / 2-pack / 5-pack

**Material** (material): **Björk** (birch)

**Färgval** (colour): s. (p.) 232 - 233

Standard  
#1.1.076

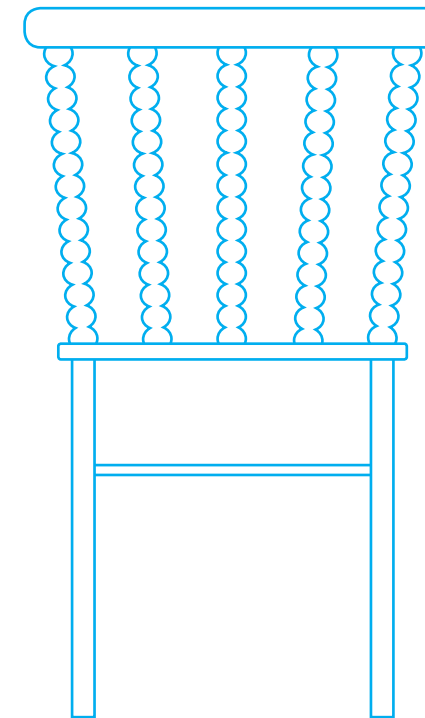

Alternativ  
#2.1.076+077+078

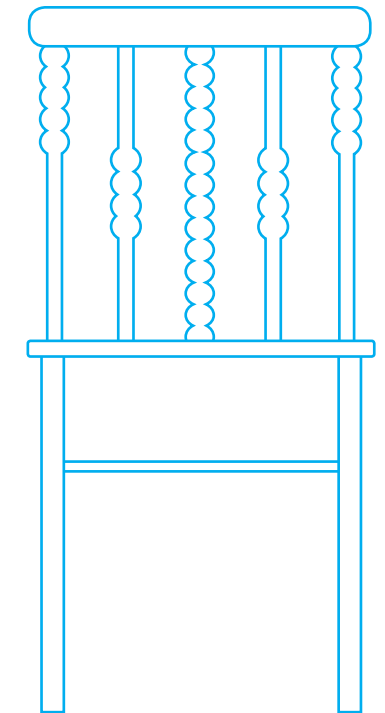

Produkten finns i flera utföranden, s. 6 - 7. (The product is available in several designs, p. 6 - 7.)



# 077

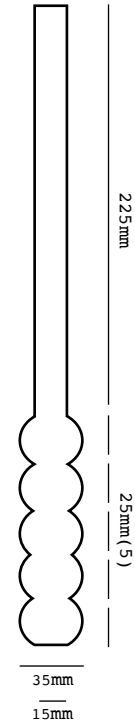

**PRODUKTFAKTA**

**Pinnar** (spindles): 1-pack / 2-pack / 5-pack

**Material** (material): **Björk** (birch)

**Färgval** (colour): s. (p.) 232 - 233

Standard  
#1.1.077

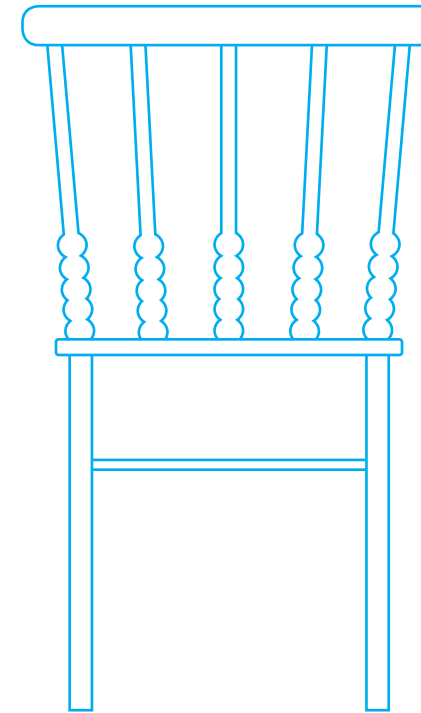

Alternativ  
#1.3.077+078

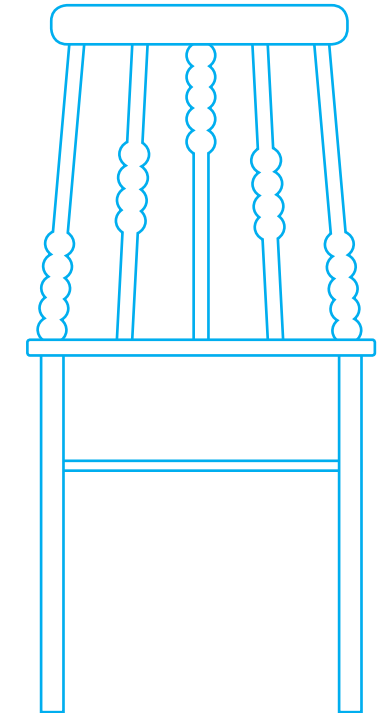

Produkten finns i flera utföranden, s. 6 - 7. (The product is available in several designs, p. 6 - 7.)



# 078

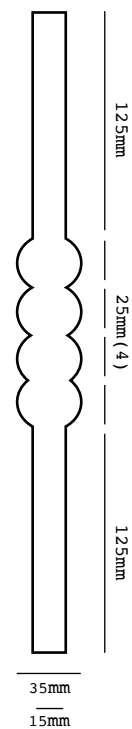

**PRODUKTFAKTA**

**Pinnar** (spindles): 1-pack / 2-pack / 5-pack

**Material** (material): **Björk** (birch)

**Färgval** (colour): s. (p.) 232 - 233

Standard  
#1.1.078

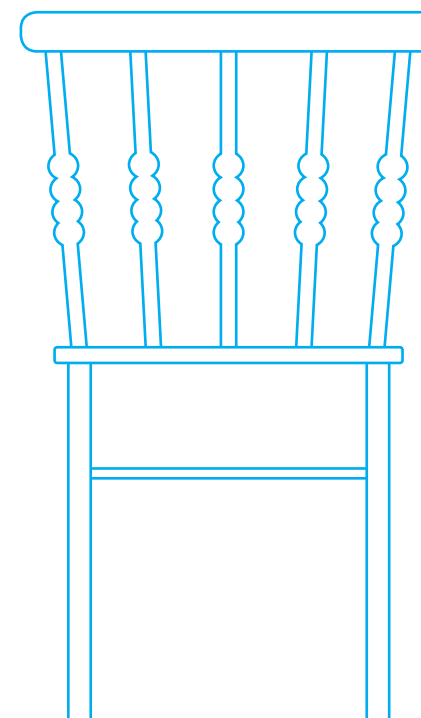

Alternativ  
#2.1.078+080

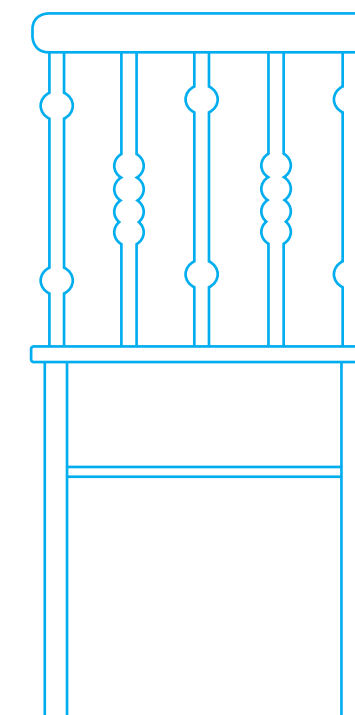

Produkten finns i flera utföranden, s. 6 - 7. (The product is available in several designs, p. 6 - 7.)



# 079

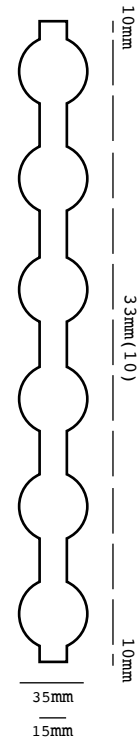

**PRODUKTFAKTA**

**Pinnar** (spindles): 1-pack / 2-pack / 5-pack

**Material** (material): **Björk** (birch)

**Färgval** (colour): s. (p.) 232 - 233

Standard  
#1.1.079

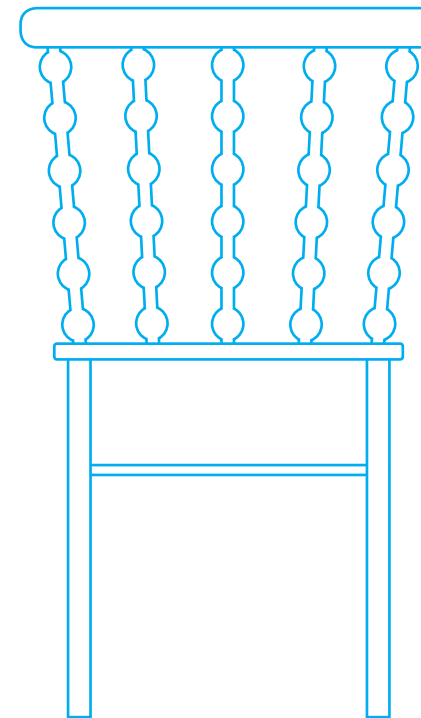

Alternativ  
#1.2.054+079

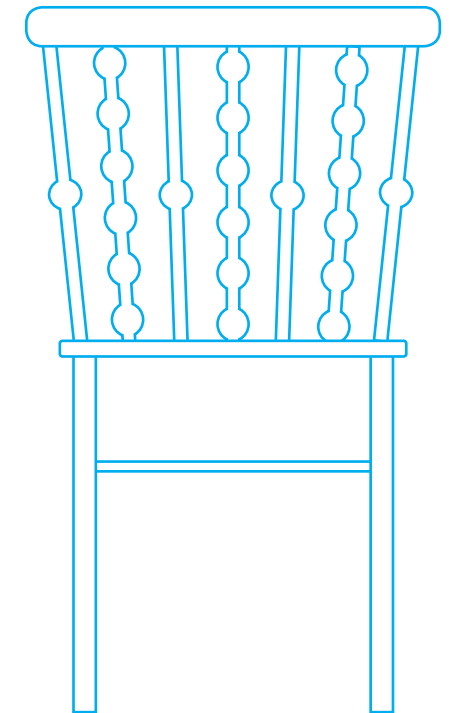

Produkten finns i flera utföranden, s. 6 - 7. (The product is available in several designs, p. 6 - 7.)



# 080

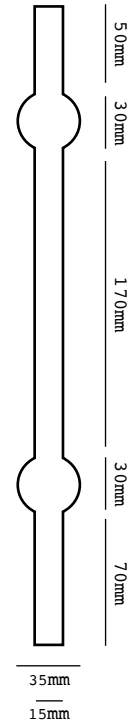

**PRODUKTFAKTA**

**Pinnar** (spindles): 1-pack / 2-pack / 5-pack

**Material** (material): Björk (birch)

**Färgval** (colour): s. (p.) 232 - 233

Standard  
#1.1.080

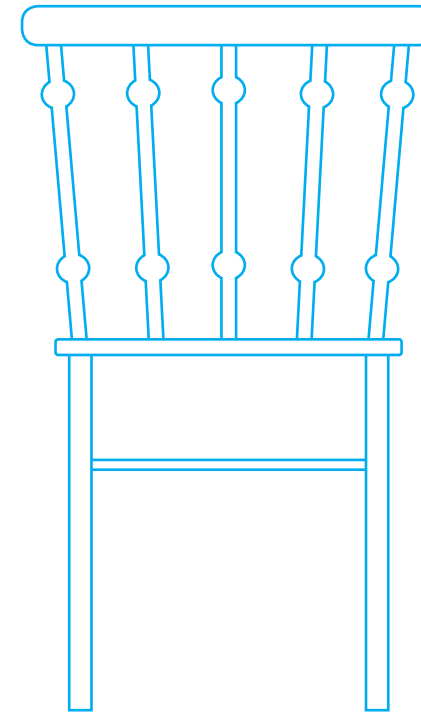

Alternativ  
#2.2.054+080

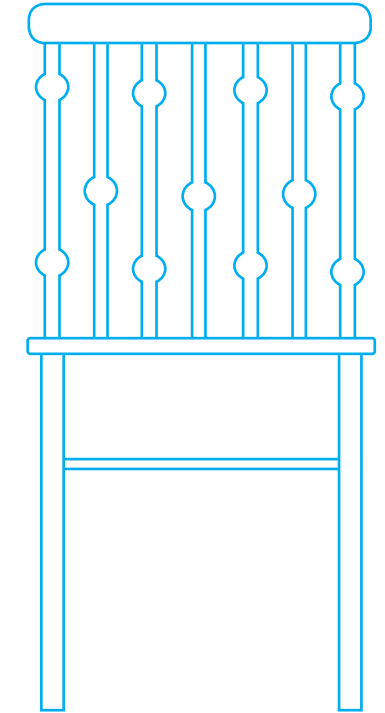

Produkten finns i flera utföranden, s. 6 - 7. (The product is available in several designs, p. 6 - 7.)

***Den bubbliga kollektionen***  
*(The Bubbly Collection)*

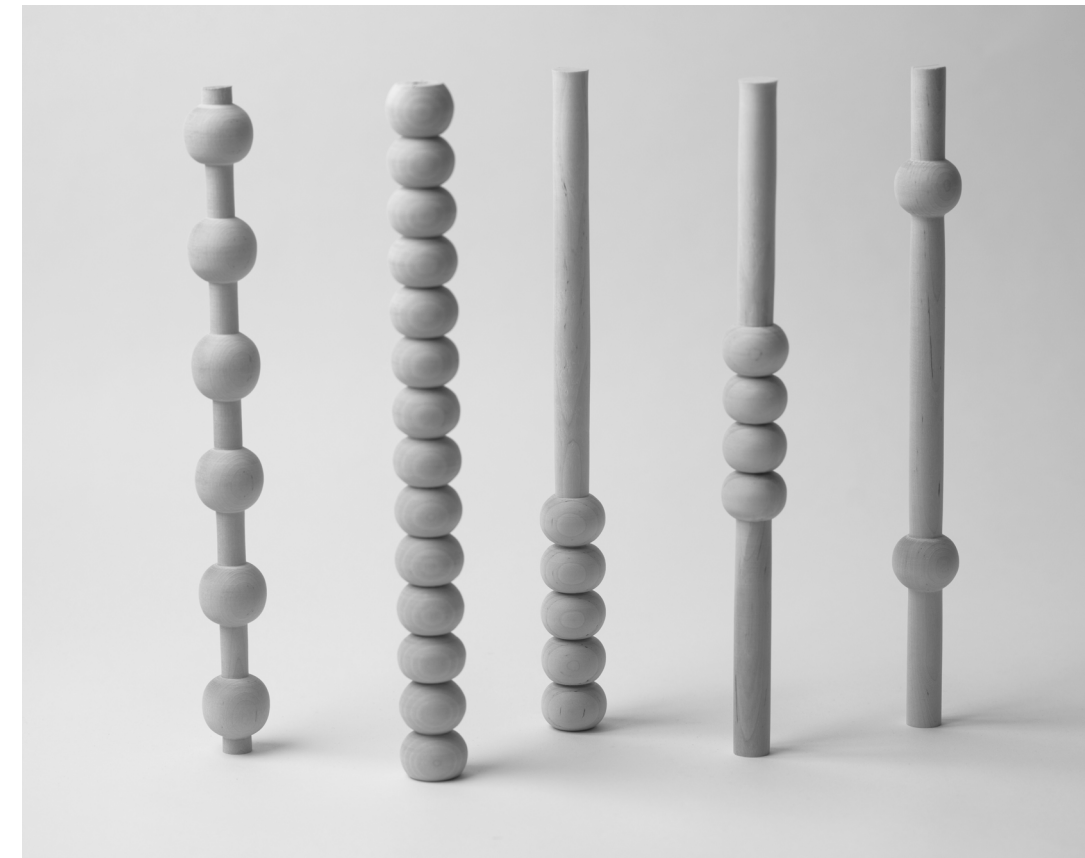





# 081

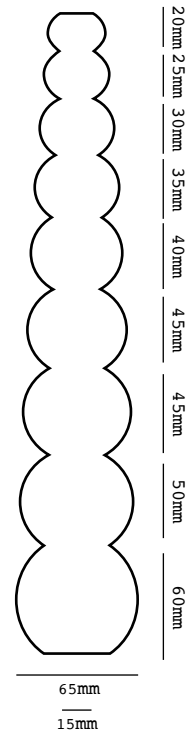

## PRODUKTFAKTA

**Pinnar** (spindles): 1-pack / 2-pack / 5-pack

**Material** (material): Björk (birch)

**Färgval** (colour): s. (p.) 232 - 233

Standard  
#1.1.081

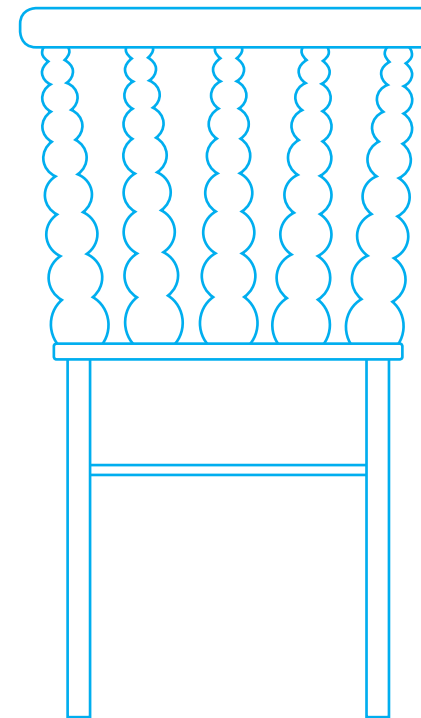

Alternativ  
#1.3.003+081

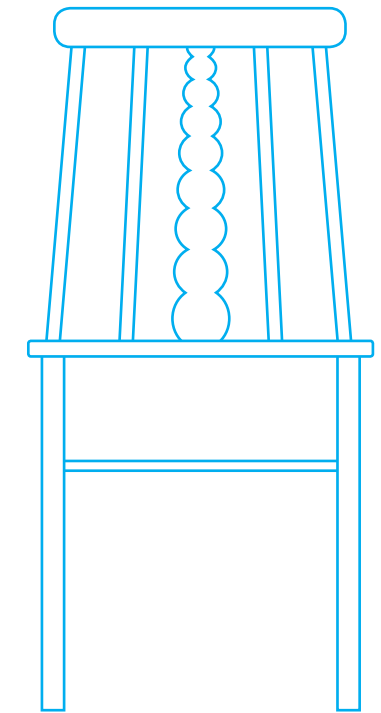

Produkten finns i flera utföranden, s. 6 - 7. (The product is available in several designs, p. 6 - 7.)



# 082

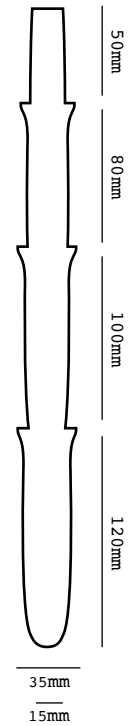

**PRODUKTFAKTA**

**Pinnar** (spindles): 1-pack / 2-pack / 5-pack

**Material** (material): **Björk** (birch)

**Färgval** (colour): s. (p.) 232 - 233

Standard  
#1.1.082

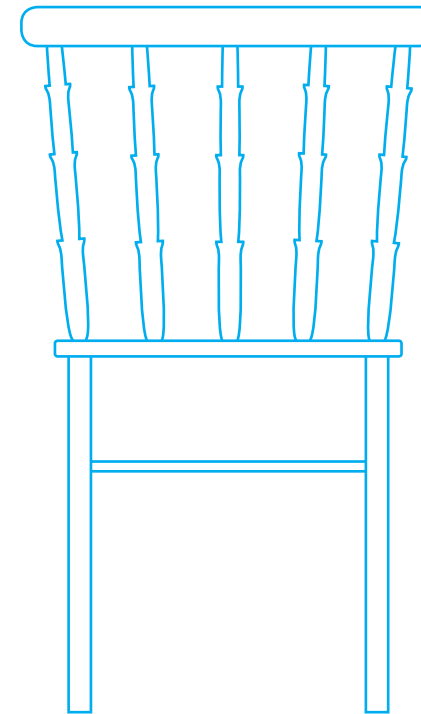

Alternativ  
#1.1.082+088

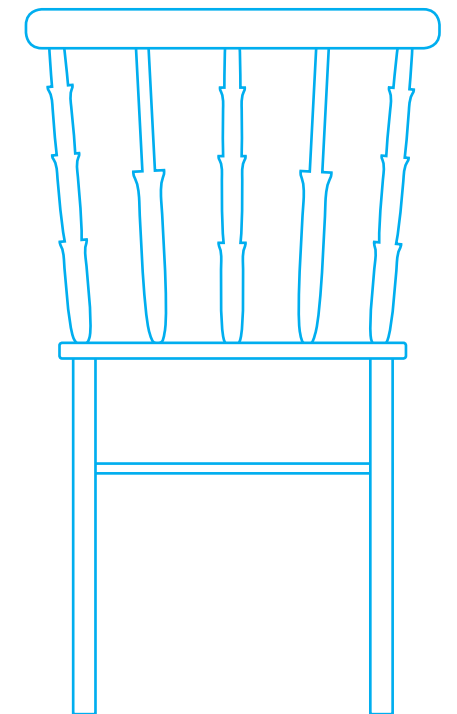

Produkten finns i flera utföranden, s. 6 - 7. (The product is available in several designs, p. 6 - 7.)



# 083

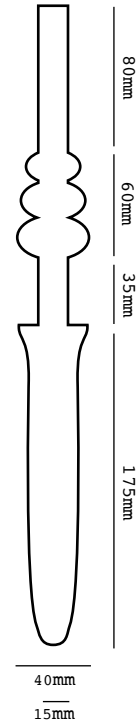

**PRODUKTFAKTA**

**Pinnar** (spindles): 1-pack / 2-pack / 5-pack

**Material** (material): **Björk** (birch)

**Färgval** (colour): s. (p.) 232 - 233

Standard  
#1.1.083

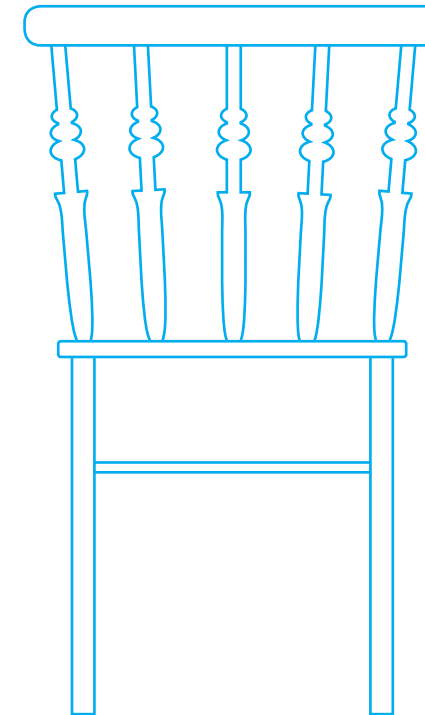

Alternativ  
#2.1.083+088

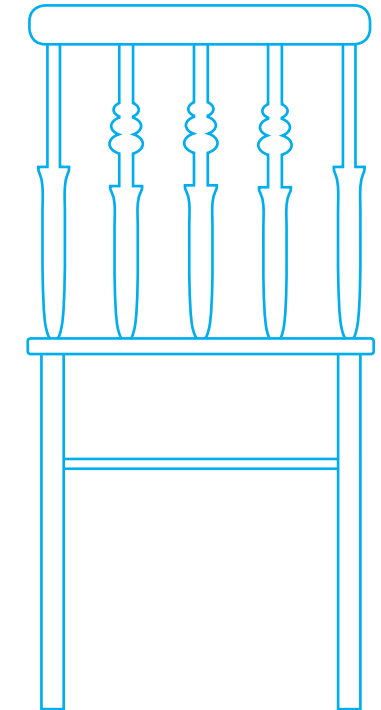

Produkten finns i flera utföranden, s. 6 - 7. (The product is available in several designs, p. 6 - 7.)



# 084

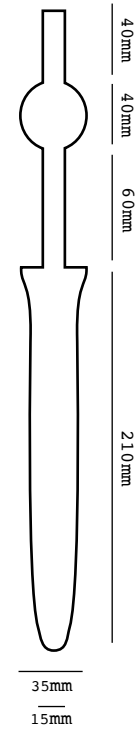

**PRODUKTFAKTA**

**Pinnar** (spindles): 1-pack / 2-pack / 5-pack

**Material** (material): **Björk** (birch)

**Färgval** (colour): s. (p.) 232 - 233

Standard  
#1.1.084

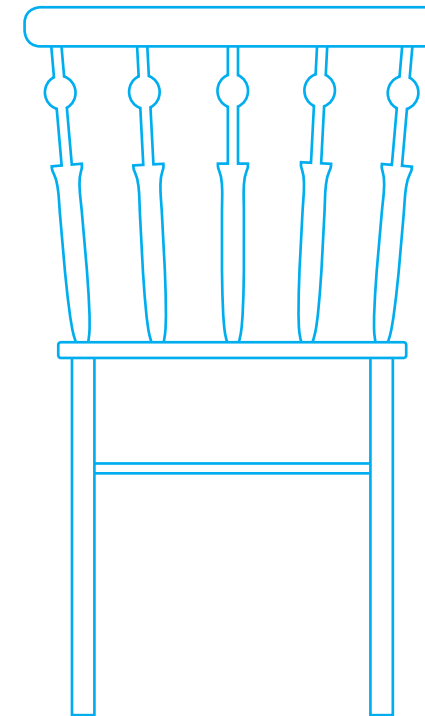

Alternativ  
#2.1.074+084

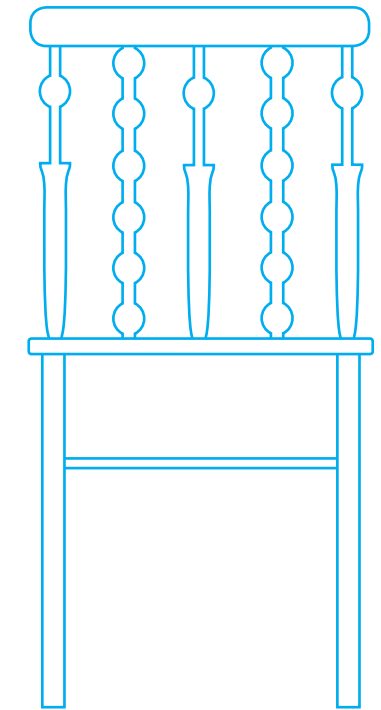

Produkten finns i flera utföranden, s. 6 - 7. (The product is available in several designs, p. 6 - 7.)



# 085

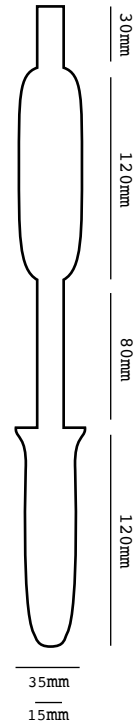

**PRODUKTFAKTA**

**Pinnar** (spindles): 1-pack / 2-pack / 5-pack

**Material** (material): **Björk** (birch)

**Färgval** (colour): s. (p.) 232 - 233

Standard  
#1.1.085

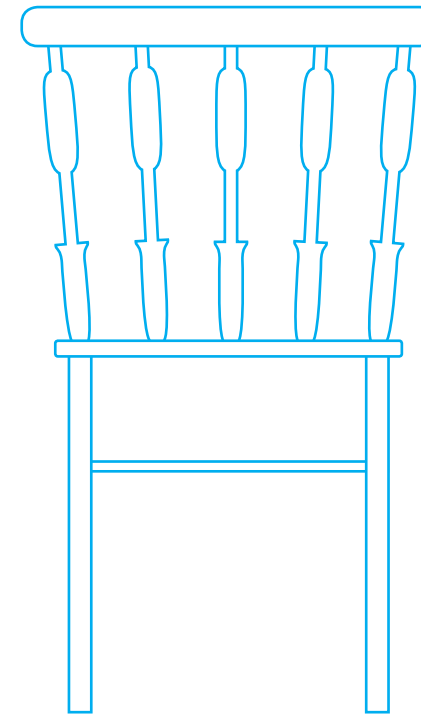

Alternativ  
#1.1.084+085

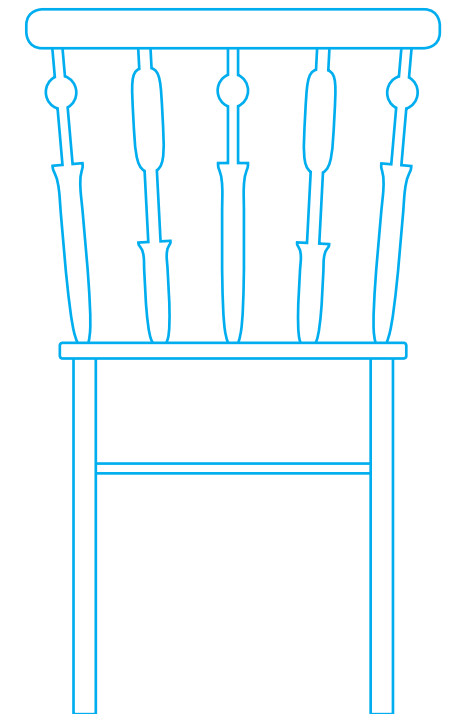

Produkten finns i flera utföranden, s. 6 - 7. (The product is available in several designs, p. 6 - 7.)



# 086

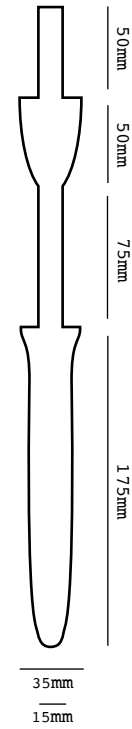

**PRODUKTFAKTA**

**Pinnar** (spindles): 1-pack / 2-pack / 5-pack

**Material** (material): **Björk** (birch)

**Färgval** (colour): s. (p.) 232 - 233

Standard  
#1.1.086

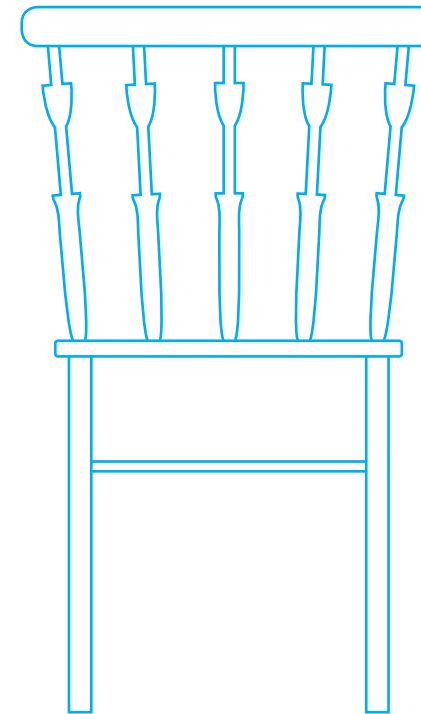

Alternativ  
#1.3.086

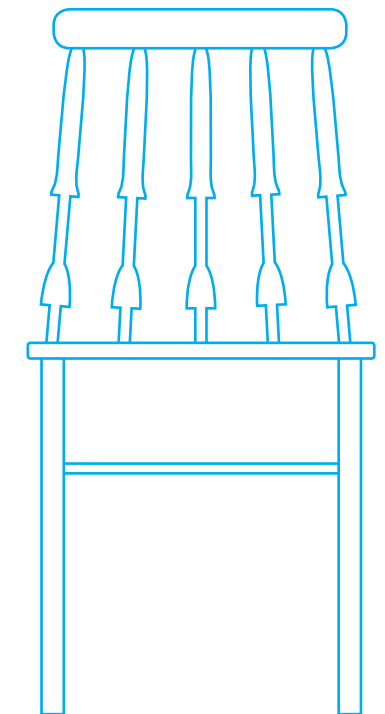

Produkten finns i flera utföranden, s. 6 - 7. (The product is available in several designs, p. 6 - 7.)



# 087

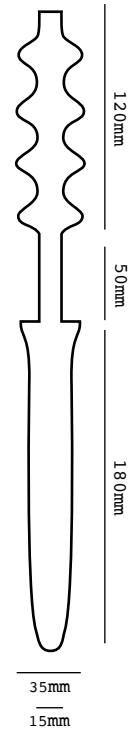

**PRODUKTFAKTA**

**Pinnar** (spindles): 1-pack / 2-pack / 5-pack

**Material** (material): **Björk** (birch)

**Färgval** (colour): s. (p.) 232 - 233

Standard  
#1.1.087

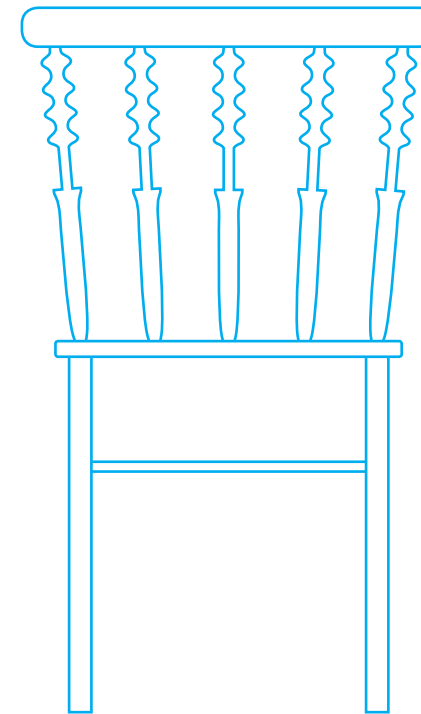

Alternativ  
#1.1.083+084+085+086+087

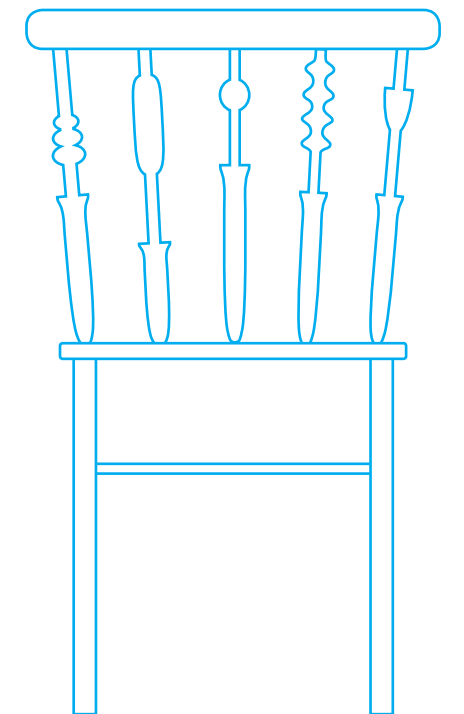

Produkten finns i flera utföranden, s. 6 - 7. (The product is available in several designs, p. 6 - 7.)



# 088

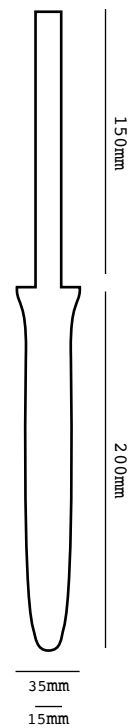

**PRODUKTFAKTA**

**Pinnar** (spindles): 1-pack / 2-pack / 5-pack

**Material** (material): **Björk** (birch)

**Färgval** (colour): s. (p.) 232 - 233

Standard  
#1.1.088

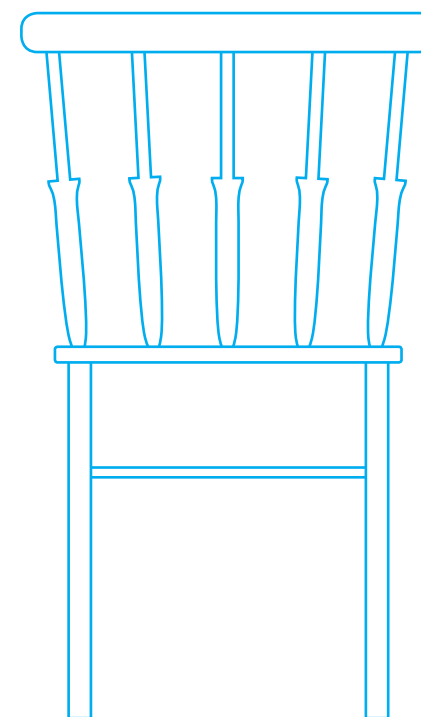

Alternativ  
#2.1.083+084+085+086+087+088

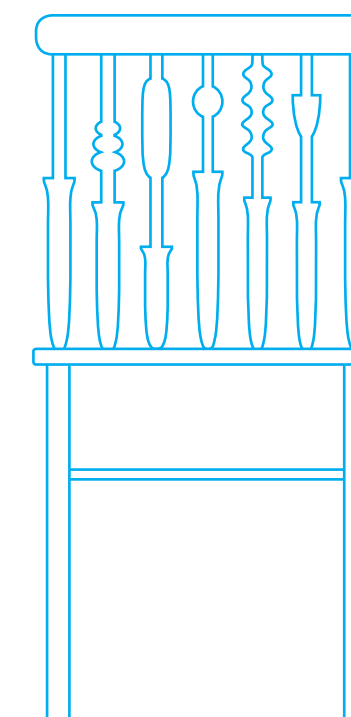

Produkten finns i flera utföranden, s. 6 - 7. (The product is available in several designs, p. 6 - 7.)



**Buketten**  
*(The Bouquet)*

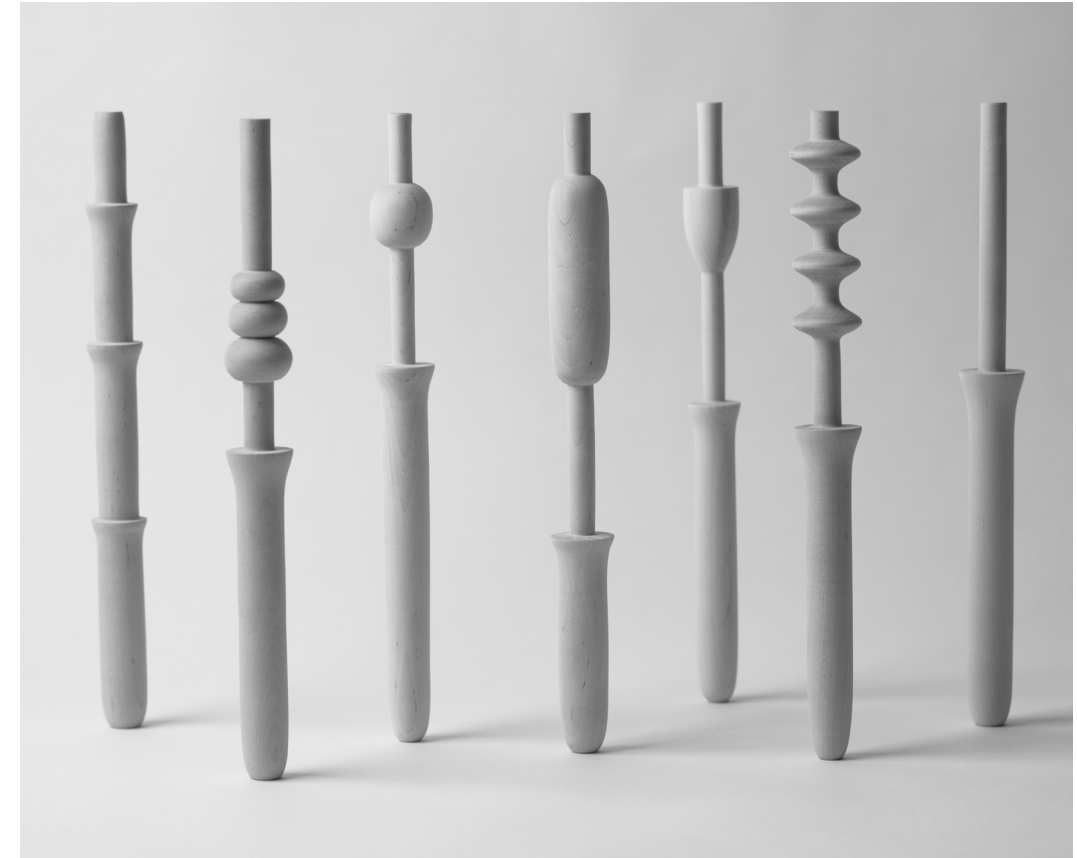



# 089

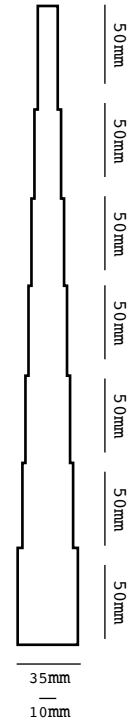

## PRODUKTFAKTA

**Pinnar** (spindles): 1-pack / 2-pack / 5-pack

**Material** (material): **Björk** (birch)

**Färgval** (colour): s. (p.) 232 - 233

Standard  
#1.1.089

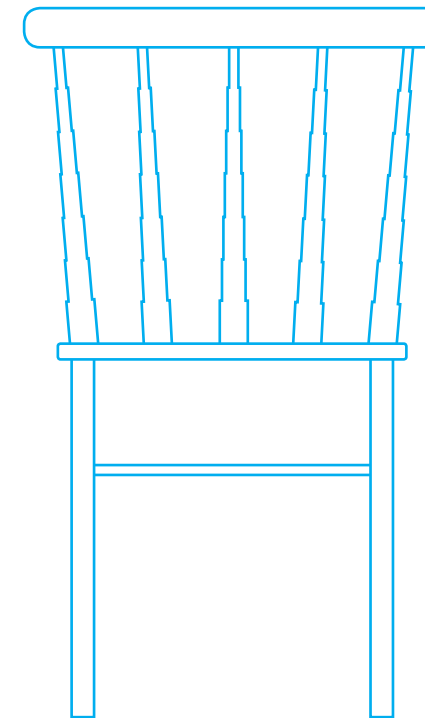

Alternativ  
#2.1.089

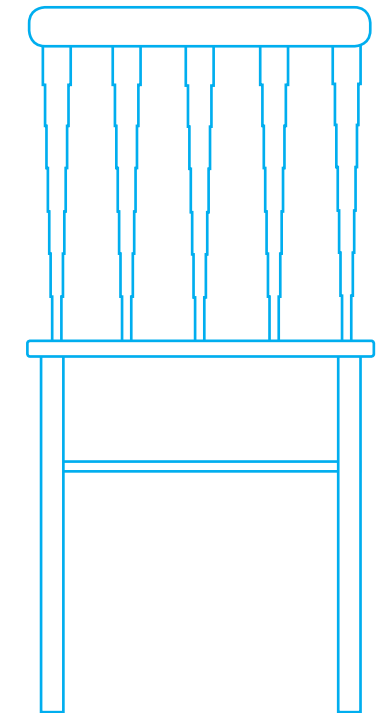

Produkten finns i flera utföranden, s. 6 - 7. (The product is available in several designs, p. 6 - 7.)



# 090

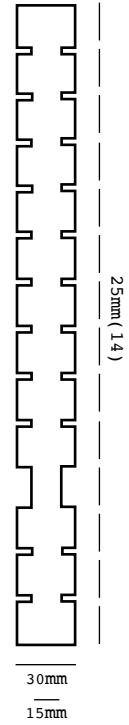

**PRODUKTFAKTA**

**Pinnar** (spindles): 1-pack / 2-pack / 5-pack

**Material** (material): **Björk** (birch)

**Färgval** (colour): s. (p.) 232 - 233

Standard  
#1.1.090

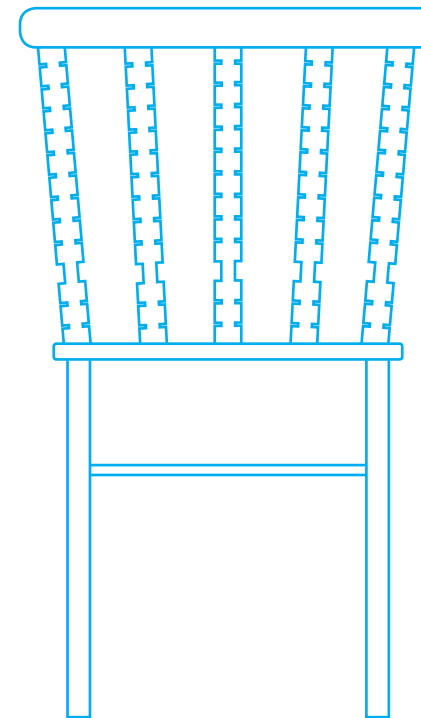

Alternativ  
#2.1.018+090

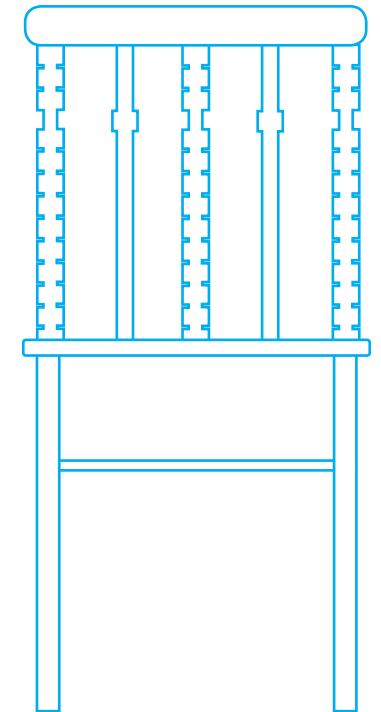

Produkten finns i flera utföranden, s. 6 - 7. (The product is available in several designs, p. 6 - 7.)



# 091

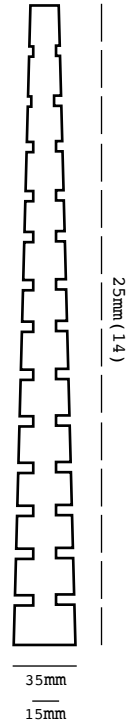

**PRODUKTFAKTA**

**Pinnar** (spindles): 1-pack / 2-pack / 5-pack

**Material** (material): **Björk** (birch)

**Färgval** (colour): s. (p.) 232 - 233

Standard  
#1.1.091

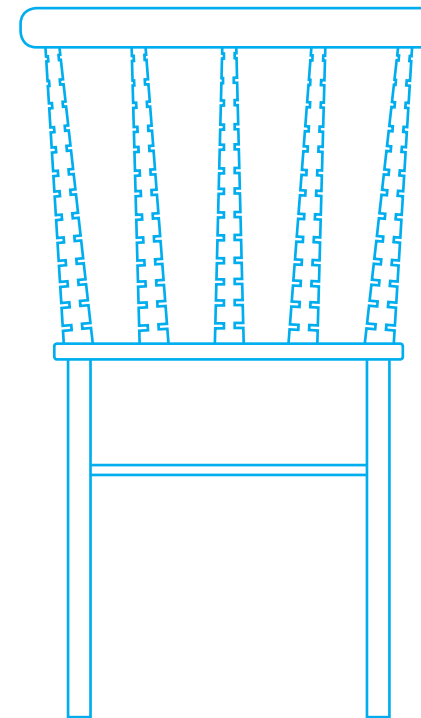

Alternativ  
#1.3.091

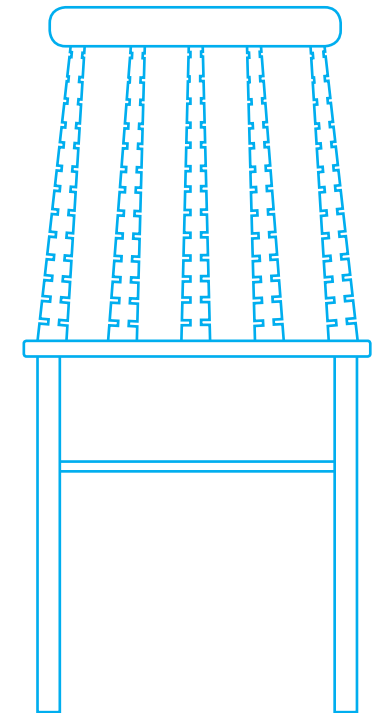

Produkten finns i flera utföranden, s. 6 - 7. (The product is available in several designs, p. 6 - 7.)



# 092

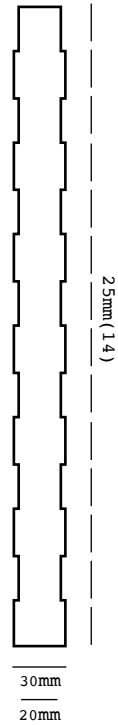

## PRODUKTFAKTA

**Pinnar** (spindles): 1-pack / 2-pack / 5-pack

**Material** (material): **Björk** (birch)

**Färgval** (colour): s. (p.) 232 - 233

Standard  
#1.1.092

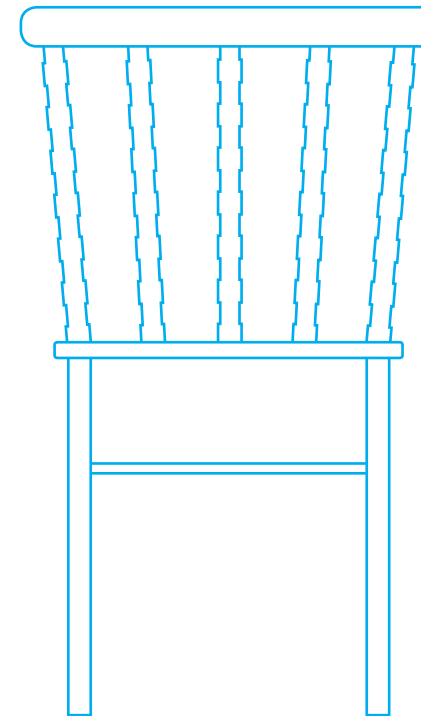

Alternativ  
#2.2.092

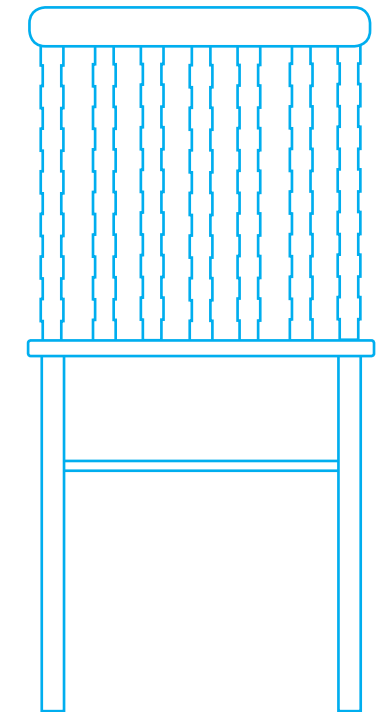

Produkten finns i flera utföranden, s. 6 - 7. (The product is available in several designs, p. 6 - 7.)



# 093

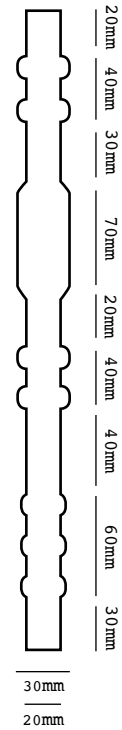

## PRODUKTFAKTA

**Pinnar** (spindles): 1-pack / 2-pack / 5-pack

**Material** (material): **Björk** (birch)

**Färgval** (colour): s. (p.) 232 - 233

Standard  
#1.1.093

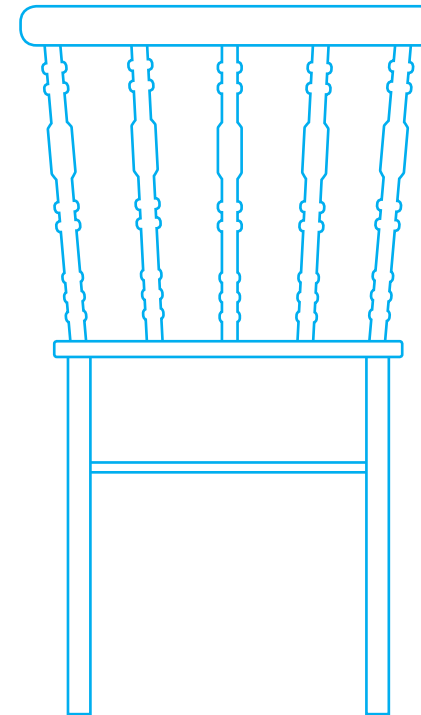

Alternativ  
#1.2.003+093

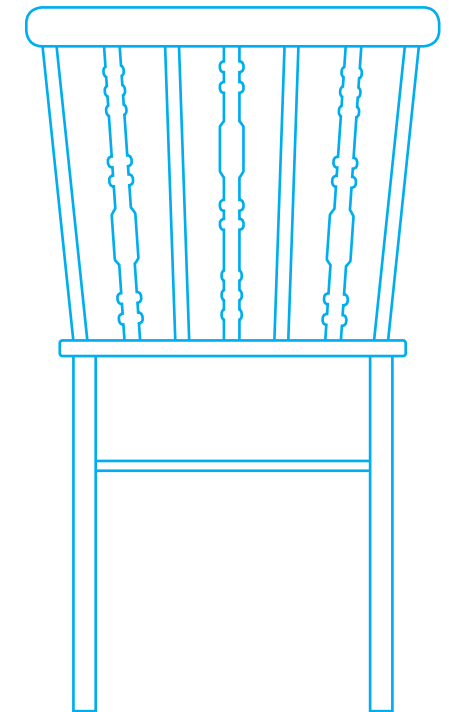

Produkten finns i flera utföranden, s. 6 - 7. (The product is available in several designs, p. 6 - 7.)



# 094

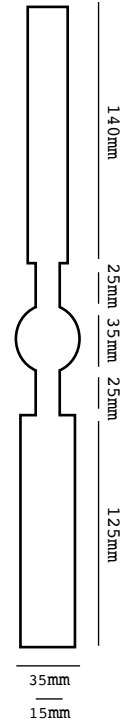

**PRODUKTFAKTA**

**Pinnar** (spindles): 1-pack / 2-pack / 5-pack

**Material** (material): **Björk** (birch)

**Färgval** (colour): s. (p.) 232 - 233

Standard  
#1.1.094

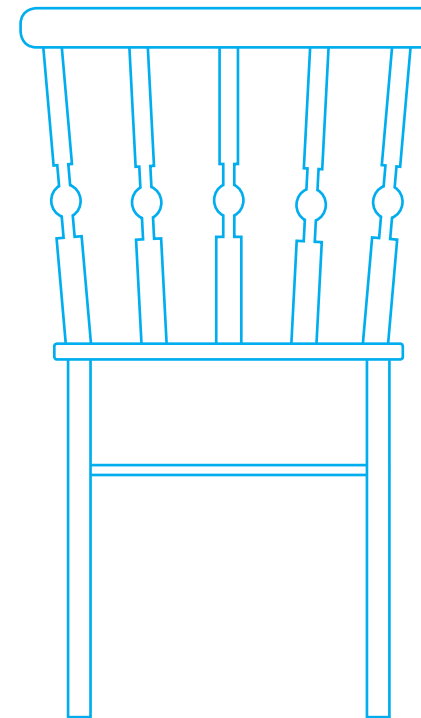

Alternativ  
#2.2.019+094

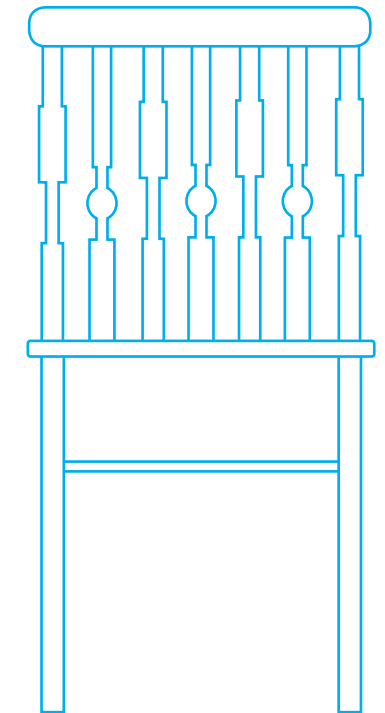

Produkten finns i flera utföranden, s. 6 - 7. (The product is available in several designs, p. 6 - 7.)



# 095

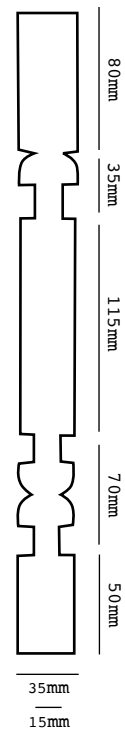

**PRODUKTFAKTA**

**Pinnar** (spindles): 1-pack / 2-pack / 5-pack

**Material** (material): **Björk** (birch)

**Färgval** (colour): s. (p.) 232 - 233

Standard  
#1.1.095

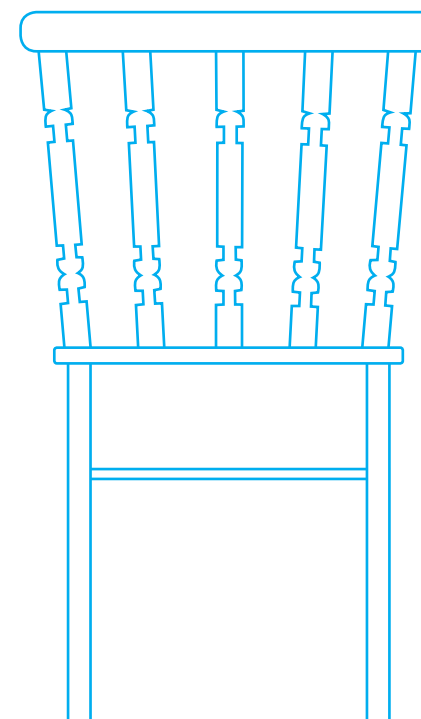

Alternativ  
#1.1.095+096

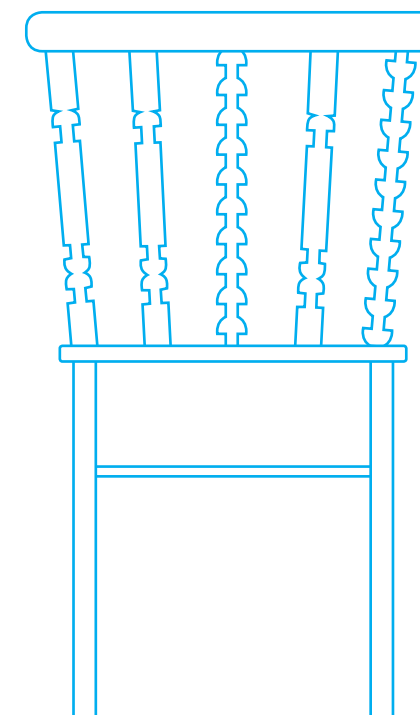

Produkten finns i flera utföranden, s. 6 - 7. (The product is available in several designs, p. 6 - 7.)





# 096

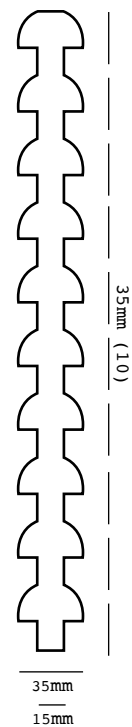

**PRODUKTFAKTA**

**Pinnar** (spindles): 1-pack / 2-pack / 5-pack

**Material** (material): **Björk** (birch)

**Färgval** (colour): s. (p.) 232 - 233

Standard  
#1.1.096

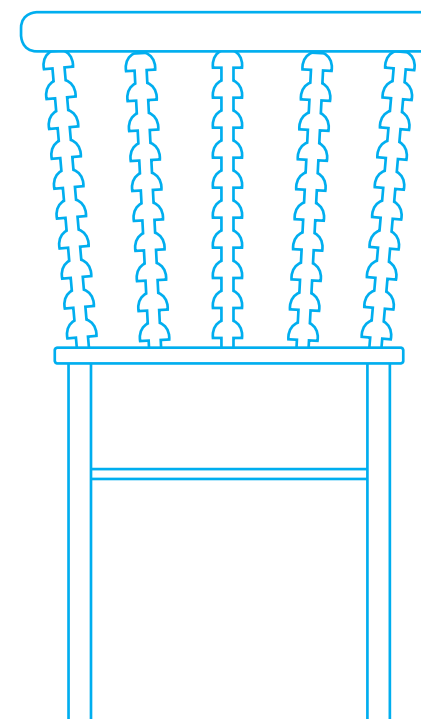

Alternativ  
#2.1.096

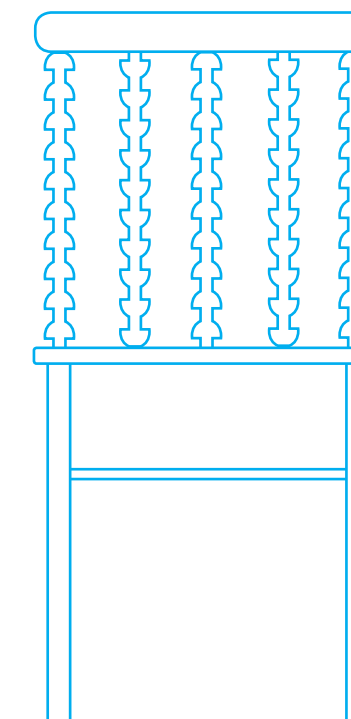

Produkten finns i flera utföranden, s. 6 - 7. (The product is available in several designs, p. 6 - 7.)



# 097

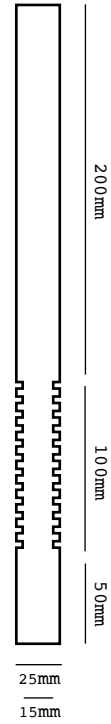

## PRODUKTFAKTA

**Pinnar** (spindles): 1-pack / 2-pack / 5-pack

**Material** (material): **Björk** (birch)

**Färgval** (colour): s. (p.) 232 - 233

Standard  
#1.1.097

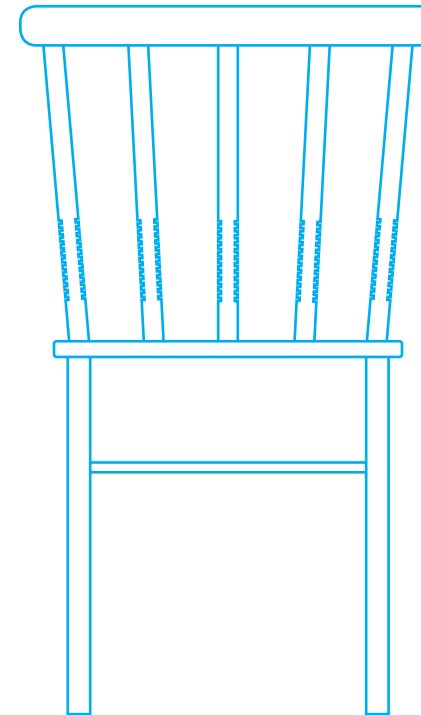

Alternativ  
#1.1.004+097

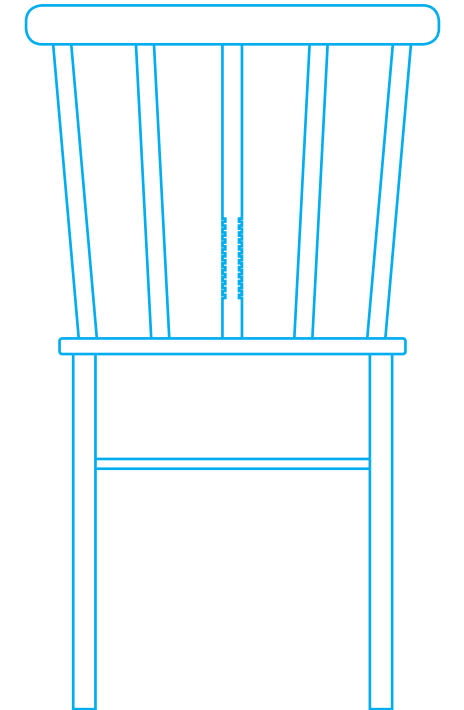

Produkten finns i flera utföranden, s. 6 - 7. (The product is available in several designs, p. 6 - 7.)

# 098

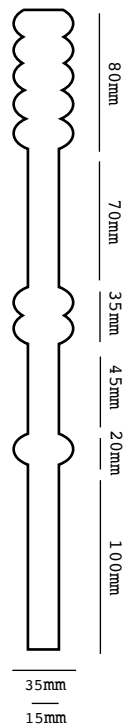

## PRODUKTFAKTA

**Pinnar** (spindles): 1-pack / 2-pack / 5-pack

**Material** (material): Björk (birch)

**Färgval** (colour): s. (p.) 232 - 233

Standard  
#1.1.098

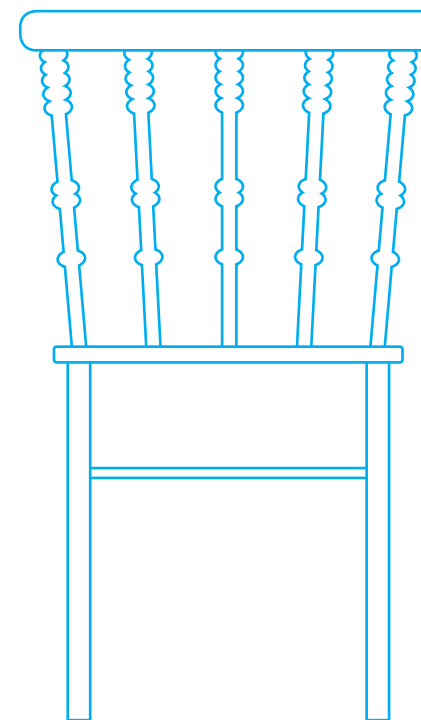

Alternativ  
#2.1.098

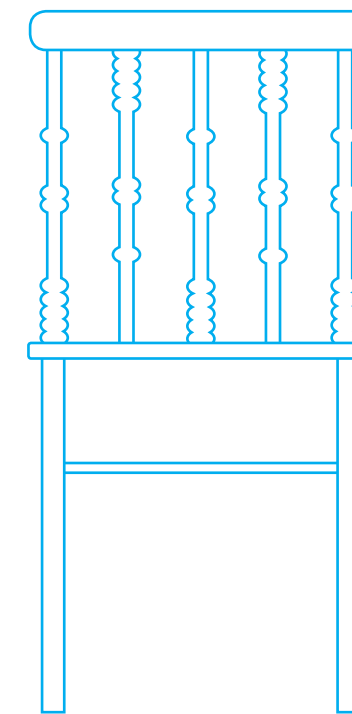

Produkten finns i flera utföranden, s. 6 - 7. (The product is available in several designs, p. 6 - 7.)



# 099

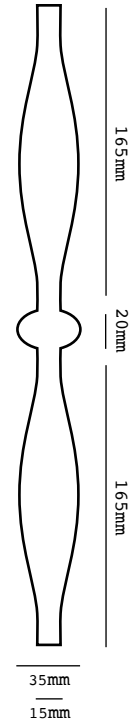

**PRODUKTFAKTA**

**Pinnar** (spindles): 1-pack / 2-pack / 5-pack

**Material** (material): **Björk** (birch)

**Färgval** (colour): s. (p.) 232 - 233

Standard  
#1.1.099

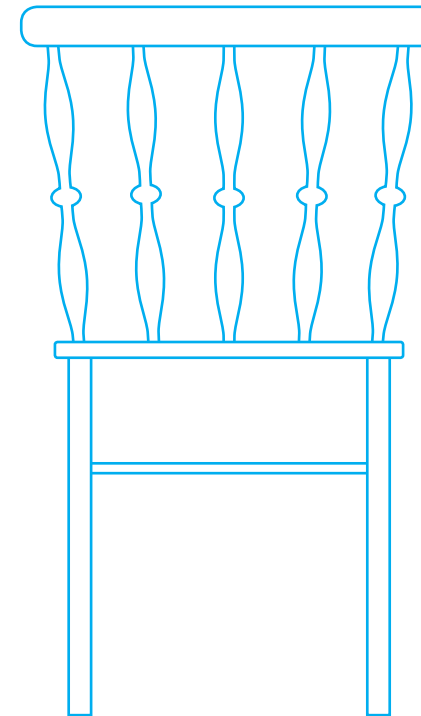

Alternativ  
#1.2.099

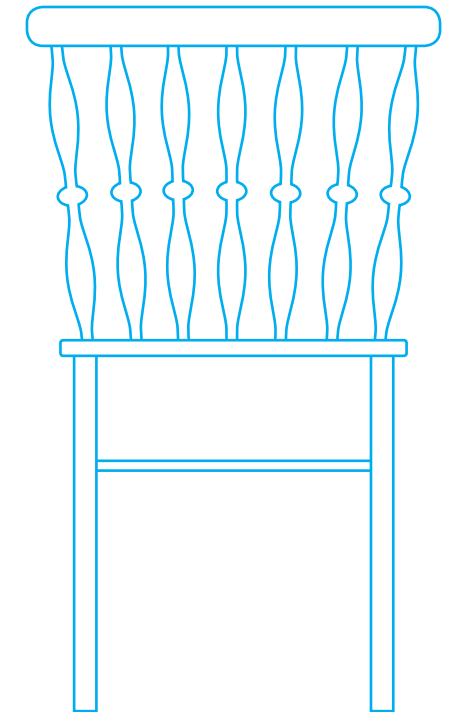

Produkten finns i flera utföranden, s. 6 - 7. (The product is available in several designs, p. 6 - 7.)



# 100

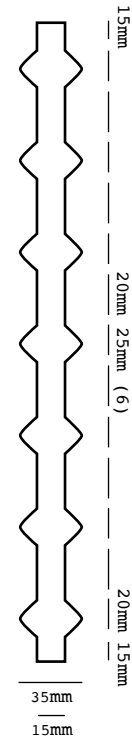

**PRODUKTFAKTA**

**Pinnar (spindles):** 1-pack / 2-pack / 5-pack

**Material (material):** Björk (birch)

**Färgval (colour):** s. (p.) 232 - 233

Standard  
#1.1.100

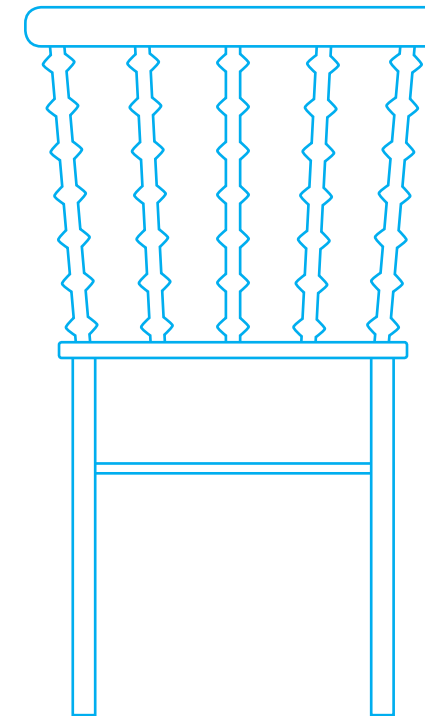

Alternativ  
#2.1.075+100

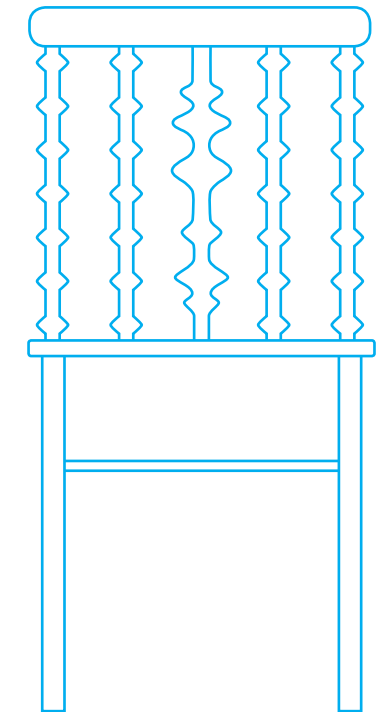

Produkten finns i flera utföranden, s. 6 - 7. (The product is available in several designs, p. 6 - 7.)

F Ä R G  
( c o l o u r )

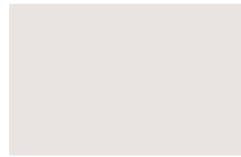

creamy white  
#efeae9



black beauty  
#131312



beige babe  
#e4d9c6



yey grey  
#b0aba9



very yellow  
#fed00



orange pop  
#e95519



reddish red  
#e31513



bubbly pink  
#ee7d9c



terracotta  
#a8533d



mustard  
#fab842



dusty pink  
#ca9093



purple rain  
#a587ae



sky  
#9ed8f7



kings blue  
#124295



navy blue  
#132259



forest green  
#1b413b



dreamy blue  
#498aa0



mint  
#a9c6ab



foggy green  
#7e9192



khaki  
#928d5f



Katalogen trycktes första gången i april 2021.

**Elias Dahlen** har hjälpt till med fotografering.  
Tusen tack! Det hade varit omöjligt utan dig.

